

Knowledge Transfer **2014**



Contents

4 | Message from the Director-General

5 | Executive summary

6 | From physics to medicine

The CERN Medical Applications office
KT Life Sciences
Detectors and accelerators for medicine

21 | Technology Transfer and Intellectual Property Management

Patent portfolio management at CERN
Patents
Trademarks
Selection of TT cases
BE and EN Department Innovation Days

34 | KT Fund

2014 projects
On-going projects
Impacts of completed projects

39 | Innovation for business

Business Incubation Centres of CERN Technologies
Innovation Events and Initiatives

43 | Knowledge exchanges

Networks
Open knowledge
EU-funded research collaborations
International organizations
KT through procurement
Knowledge-sharing events

52 | Training and education

KT training for CERN staff
Training programmes
Marie Curie Actions
Marie Curie RISE INTELUM project
The general public and teachers
Career study of former CERN fellows
CERN Spring Campus
CERN schools



Rolf Heuer,
Director-General

In 2014 CERN and its Member States celebrated 60 years of science for peace. Only a decade after the Second World War, 12 European countries joined forces in 1954 to build what has become the world's largest particle-physics laboratory. The vision of the founders included dissemination of information – an ideal that underlies CERN's programmes for knowledge and technology transfer to a wider society in the now 21 Member States.

The Laboratory plays a vital role in developing technologies for the future, and its partnerships with industry give companies expertise they can apply elsewhere. In 2014, Business Incubation Centres of CERN Technologies started up in four Member States. With the one set up in the UK in 2012, they form a network to turn innovative ideas into business opportunities. At the 2014 Hannover Messe, CERN and the European Space Agency, together with a number of their spin-off companies displayed successful examples of knowledge transfer to industry. And IdeaSquare has started up at CERN as a new springboard for innovation.

The know-how obtained in particle physics drives progress in many fields. Medical applications, for example, are now reaching a maturity that was evident at the ICTR-PHE 2014 conference, co-organized by CERN, which brought together experts in physics, engineering, medicine, computer science and biology.

Over the past 60 years CERN has made important contributions that go well beyond its scientific impact. This report shows that it is well placed to continue enabling its know-how to reach society for the benefit of all.

Executive summary

2014 has been another very fruitful year for CERN's Knowledge Transfer (KT) activities.

The medical field continues to be the most important application field for the Laboratory's technologies and know-how (p. 6), and the creation of the CERN Medical Applications office is helping to optimize the transfer to society, thanks also to the advice of its International Strategy Committee.

The dissemination of the Intellectual Property generated by the Organization (often in collaboration with other institutes) is steadily increasing year on year, with still more opportunities being identified and KT contracts being signed in 2014 compared to previous years. Several examples are illustrated in the second chapter (p. 21).

The KT Fund (p. 34) is now established as a very useful tool to reduce the gap from fundamental research to applications, and to incentivize CERN researchers to bring forward their ideas. Since its inception in 2011, the fund has financed 25 projects, 6 of these in 2014.

The idea of a network of Business Incubation Centres (BICs) of CERN Technologies in the Member States became closer to reality in 2014, thanks to the establishment of four new BICs in The Netherlands, Norway, Greece and Austria (p. 39); with the STFC CERN BIC, there are now five centres to help bring CERN's

knowledge to the market by assisting small start-up companies. Knowledge transfer and exchange continued to be fostered in 2014 by CERN's participation to various networks (p. 43), open knowledge initiatives and EC-funded projects, and through exchanges with international organizations or companies in the execution of procurement contracts.

Last but not least, CERN's training and education programmes (p. 52) are one of the most effective ways of sharing the Organization's knowledge with the outside world.

As in the past years, this report presents the activities of the KT Group and other important examples of knowledge transfer from CERN to society. We would like to thank all the people who contributed to this report for their help in its preparation and, most importantly, for supporting with their daily work the Organization's knowledge-transfer mission.

Thierry Lagrange

Head of the Finance, Procurement and Knowledge Transfer Department

Giovanni Anelli

Head of the Knowledge Transfer Group

cern.ch/knowledgetransfer



Carbon-ion gantry at the Heidelberg Ion-Beam Therapy Centre, Germany

From physics to medicine

State-of-the-art techniques borrowed from particle accelerators, detectors and physics computing are increasingly used in the medical field for both diagnosis and treatment of a variety of diseases.

CERN's commitment to formalizing the transfer of knowledge developed in the Laboratory to the field of medicine has been growing over recent years. To this end, in January 2014 the CERN Medical Applications (CMA) office was established, with the aim of gathering all of the diverse medical physics activities within the Laboratory under a single roof.

The collaborative spirit that is a core value of CERN is increasingly valued as an essential ingredient to catalyse successful multidisciplinary ventures in the healthcare field. As tangible proof, in November 2014 CERN hosted the first meeting of the International Strategy Committee for medical applications. This committee will help the Organization establish its roadmap in the field of research and development activities for medical applications. Meanwhile, a wide range of activities and projects took place in almost all CERN's de-

partments, including within the Knowledge Transfer group, stemming from the three technology pillars of particle physics: detectors, accelerators, and large-scale computing.

All of these efforts will ensure that, wherever possible, the technology and expertise developed in the Laboratory deliver immediate and tangible benefits to society.

The CERN Medical Applications office

In January 2014, CERN's Director-General created an office for medical applications, with the aim of bringing all of the diverse medical-physics activities at CERN together under a single roof. This is the first time that CERN has put (into its medium-term plan) a budget line for medical applications. It is a small budget line, but it can be the seed for further developments and to establish collaborations with other institutes and centres.

After a lifetime in accelerator physics, Steve Myers has taken up the challenge of being the first head of this office and has appointed as his deputy, the KT Group's deputy leader, Manjit Dosanjh. The remit is to apply the three key particle-physics technologies (detectors, large-scale computing and accelerators) to the field of medicine.

The initial work-plan of the CERN Medical Applications (CMA) office includes seven key areas:

- large-scale computing
- detectors for medical imaging
- radioisotopes
- a new biomedical facility
- optimized design for medical accelerators
- simulation and dosimetry
- applications other than cancer therapy.

A 2-day kick-off meeting was held in Divonne-les-Bains, close to Geneva, in February 2014, immediately following the ICTR-PHE conference. This involved 85 international specialists in the fields of interest and resulted in constructive discussions on areas where research could improve therapy. In May 2014, an internal CERN Medical Applications Study Group (CMASG) was formed, with representatives from the seven initiatives, to make further interactive progress.

The CMASG has been meeting regularly since then and has dramatically improved the exchange of information among the various departments and groups at CERN. The participation of members of CERN's EU Projects Office ensures that relevant EC funding calls or strategy documents are quickly brought to the attention of the medical applications community. The CMA office has strong ties with the KT Group, as demonstrated by the presence of the KT group leader and deputy group leader and another member of the Life Sciences Section, in the CMASG.

In summer 2014, an International Strategy Committee was established, with members consisting of prominent experts from major institutes in Europe, the USA, China and Japan. The first meeting was held at CERN in November 2014, and the second is foreseen in Brussels in April 2015. In the first meeting, the strategy for the seven initiatives was discussed at length and endorsed by the committee. A commitment was also made to lobby for funding for the most important and urgent initiatives.

A flagship initiative of the CMA office is the establishment of OPENMED, an open-access facility for biomedical research based on the existing Low Energy Ion Ring (LEIR) at CERN. LEIR supplies heavy ions to the LHC injector chain for a period of one month per year. The beam energy, size and availability make LEIR an ideal candidate for conversion to a biomedical test-bed facility. Relatively minor modifications to LEIR would allow:

- a horizontal beam line for particle energies of up to 400 MeV per nucleon, with up to 30 cm range in tissues for testing comparative particle ballistics for different ions, dosimetry and cellular responsiveness in humanoid phantoms.
- a vertical beam line with lower particle energies, as low as 75 MeV for in vitro work using larger cell numbers for radio-sensitizing drug experiments.
- a pencil beam of 5-10 mm FWHM and broad beam of 5x5 cm are relatively easy options.

Adjacent to the LEIR hall, there is sufficient ground space for a well-equipped biological laboratory for cell culture, bio-assays and analysis. OPENMED would be open to international users focusing on radiobiology, medical instrumentation, acceleration

and beam delivery, diagnostics and dosimetry, as well as basic physics studies such as nuclear fragmentation.

Transferring technologies from particle physics to the health sector is a multidisciplinary venture. It is important that the wide scientific community and the general public are aware of the complexity and of the challenges lying ahead: for this reason, a series of Medical Applications Seminars was started. The first seminar was given in July by Eleanor Blakely from Lawrence Berkeley National Laboratory, and reviewed the 60 years since the first patient was treated with proton therapy (see p.44). In October, Douglas Hanahan, Director of the Swiss Institute for Experimental Cancer Research (ISREC), spoke about the hallmarks of cancer. In November, Hirohiko Tsujii, former Director of the Research Center for Charged Particle Therapy at the Japanese National Institute of Radiological Science, reflected on 20 years of systematic use of carbon ions in Japan, while Roberto Orecchia, Scientific Director of CNAO, presented the results obtained at the Italian centre. This joint seminar was concluded by Steve Myers, who gave an overview of the CMA activities.

During this first year of activity at the CMA office, the overall structure and several internal and external collaboration boards and committees have been set up. The LS Section has been instrumental in supporting the CMA effort and some external funding has already been secured, with further avenues being explored for additional funding. A purposeful start has been made in 2014 and this momentum must be preserved, with full international cooperation, in order to make further vital progress in association with other universities and hospital facilities worldwide.

More information: cern.ch/cern-medical

KT Life Sciences

For more than 10 years, the Life Sciences (LS) Section has been entirely dedicated to supporting the transfer of knowledge, technologies and collaboration models from CERN to the healthcare sector. So, it was natural for the section to play an important role within the new-born CMA office: in addition to the whole team actively supporting the CMA activities, the LS section leader was appointed deputy to the head of the office and another member of the section is part of the CMA Study Group established in May 2014. The support from the LS Section to the CMA covers all levels from R&D to strategy, communication and logistics, and has been instrumental in maintaining the link with the previous programmes in addition to moving the activities of this new office forward in a coherent way. In terms of organization, the section took care of all practical arrangements for various meetings and activities including the initial brainstorming workshop in February, the new series of Medical Applications Seminars and the first meeting of the International Strategy Committee. All of these activities are detailed in the sub-chapter devoted to the CMA. From both a scientific and strategic point of view, several actions helped promote the CMA projects beyond the Laboratory's boundaries.

As an example, a presentation at the 'III Course on Hadrons in Therapy and in Space' (Erice, Italy, October 2014) opened up the possibility of using the OPENMED biomedical research facility – a proposed facility that would use beams produced by the LEIR machine – for space research, in addition to the planned studies for hadron therapy, nuclear fragmentation, treatment planning, dosimetry and detector development.

In particular, the CMA office has benefited from the multidisciplinary network built by the LS team, comprising an international community of medical physicists, IT scientists, medical doctors and engineers and has had extensive beneficial exchanges with various key players ranging from the IAEA to the US National Cancer Institute.

The LS Section also supported various initiatives to identify new funding opportunities for CERN medical applications not limited to hadron therapy. Thus the proven expertise of the section in the domain of science communication and outreach has been a valuable asset for the CMA office throughout the year.

Supporting the CMA structure was a new challenge in 2014 for the LS team, which came in addition to activities already anticipated such as the organization of the ICTR-PHE conference, the wrap-up of the scientific and financial activities of two EC-funded projects (one co-ordinated by the section), the co-ordination of a Marie Curie Initial Training Network and the co-ordination of the European Network for Light Ion Hadron Therapy (ENLIGHT). These activities will be detailed in the following pages.

ICTR-PHE 2014: Where technology meets the clinic

After a successful first joint conference in 2012, the International Conference on Translational Research in Radiation Oncology (ICTR) and Physics for Health (PHE) reunited for a second time in 2014. ICTR-PHE 2014 took place on 10-14 February 2014 at the International Conference Centre of Geneva. The event attracted a large number of participants from a variety of fields, including physics, engineering, medicine, computer science and biology. The conference was a unique opportunity to discuss the latest advances in these disciplines and to catalyse new collaborations.

The conference co-chairs, Manjit Dosanjh and Jacques Bernier, along with CERN's Director-General, Rolf Heuer, opened the conference to 400 enthusiastic participants from 31 different nations. There were 180 oral presentations over 4 days of the conference covering both clinically and technologically driven subjects such as radiobiology, nuclear medicine, detectors for imaging, radioisotopes for diagnosis and therapy, and new technologies. Special symposia focused on current 'hot' topics. Leading world experts gave presentations on a variety of topics including the molecular mechanisms of radio-curability, hypoxic modification of radiotherapy, radiosensitivity modulation and tumour vascularization. It was evident from the discussions that the fight against cancer is taking on a personalized approach. Being a multi-faceted disease, cancer presents itself differently



Steve Myers presents CMA initiatives at ICTR-PHE 2014

in each patient. A tailored treatment plan is needed for each patient that takes into account the type of malignant cell, location of the tumour, morphology, etc. The idea underlying the use of tailored protocols is to understand the differences that characterize each tumour and their intrinsic heterogeneity as well as the microenvironment in which they exist. This greatly assists in finding the optimal treatment or combination of treatments for the best possible therapeutic outcome. Several of the presentations given confirmed the positive impact of a combined and co-ordinated approach on disease prognosis.

Conventional radiotherapy using a beam of photons has progressed many-fold with the onset of techniques such as intensity modulation, volumetric arc techniques and image-guided treatment. Nevertheless, the specific ways in which ions deposit their energy (the Bragg peak) makes ion therapy intrinsically more precise in targeting tumours. However, there are many factors that influence treatment effectiveness including drugs, patient immunology, hypoxia rate and the inner nature of the tumour. For example, recent studies have shown that malignant cells infected with the HPV virus respond better to radiation. A thorough understanding of the biological effects of different ion species and a combination of different treatment options leads to better therapy; hence radiobiology plays an important role.

The effectiveness of therapy partly depends on how well the tumour is defined, making imaging one of the major challenges. Imaging has reached a spatial resolution of 2 mm. The resolution and precision of imaging is continuing to grow with the use of combined modalities such as PET/CT and PET/MRI. These are important clinical breakthroughs as they combine modalities that capture the anatomical and functional aspects of tissue. Compared to PET/CT, PET/MRI machines reduce the dose of ionizing radiation given to a patient and produce higher-quality images. After 30 years of research, the challenge of operating a PET machine within a strong magnetic field has been overcome: since 2010 there have been three commercial manufacturers of PET/MRI machines.



The KT exhibition stand at the industrial exhibition

An improvement in imaging also depends on more sophisticated software and algorithms to integrate the information collected. For example, the anatomical data coming from CT or MRI imaging, including 4D acquisition, organ movement and deformation, is fed into the PET acquisition system. The reconstruction of the combined information from both systems can produce extremely accurate images. Software has other major applications including beam monitoring, dose distribution and treatment plans. Simulations made with GEANT4 and FLUKA software are used to determine the most suitable treatment plan. The first 3D mapping of the dose distribution over a known distance along the entire length of a 62 MeV proton beam was presented. Such studies are extremely useful in assessing collateral damage caused by the therapeutic beam.

The role of radiochemistry cannot be ignored — both in imaging and in therapy. Different tumours require different isotopes as malignant cells react differently to different types of radiation. The same carrier molecules that bring radioisotopes to malignant cells to make them detectable could be used with more powerful isotopes to carry a lethal dose to destroy cancer cells. The appropriate radionuclide should be identified to reach the target selectively while minimizing the effect on normal tissue. Specific peptides associated with isotopes obtained at particle detectors

and innovative nanoparticles are being studied. A challenge in this area is the proximity of radioisotope-producing particle accelerators to hospitals. The Proton Isotope Produce (PIP), an innovative accelerator design based on recirculation, aims to overcome the typical issues related to installation and operation of cyclotrons in the medical environment.

Evidence-based medicine is the way forward, where each idea and method must be tested and preclinical and clinical tests performed. Proton beams have been used therapeutically for 60 years and carbon ion beams for 20 years, but despite this, full-phase clinical trial data remain incomplete. A panel discussion dedicated to addressing the topic of randomized clinical trials proved to be a popular event of the conference. Topics being studied in trials include the integrated dose being delivered, fractionation and types of tumours being treated. The hurdles to overcome before a meaningful clinical trial is conducted are ethical issues and methodological concerns. Some tumour types are rare and data are consequently scarce. Data confidentiality is also a major concern, especially when setting up multi-centre trials.

The proffered paper sessions in physics, biology and radiotherapy gave opportunities to young students to present their work to an international audience and get valuable feedback from leading experts. Lunch and coffee breaks were occasions not only to continue discussions from the conference room and socialize, but also to browse the scientific posters on display and the industrial exhibitions including IBA, Varian Medical Systems, Mevion Medical Systems, Xstrahl and Oncology Systems Limited.

The takeaway message from the 4 days of scientific presentations, discussions and collaboration-building was that the common goal — to improve cancer management — is the binding glue of this scientific community. ICTR-PHE was the ideal platform to discuss work done so far and define future direction. We eagerly look forward to this convergence of experts at the third ICTR-PHE, which will take place in Geneva on 29 February - 4 March 2016.

Reaching out

The public seminar, which was translated in real-time into French, was given by Ugo Amaldi. He spoke about the beauty of physics and CERN's contributions to cancer therapy. This lecture also celebrated his 80th birthday. In addition, the conference featured a lecture on the discovery of the Higgs boson, by Fabiola Gianotti, former spokesperson of the ATLAS experiment at CERN and the future Director-General of CERN. She relayed to the audience the story of many years of Higgs hunting and the relevance of the discovery.

CERN's KT Group and the ENLIGHT network took part in the industrial exhibition that was open throughout the conference. Lunch and coffee breaks provided ample time for participants to browse stands and engage in discussions.

ULICE

The Union of Light Ion Centres in Europe (ULICE) was launched in 2009 to address the need for the ion-therapy research facilities and treatment centres in Europe to network and collaborate. Following an extension by one year to allow deliverables to be met, the final ULICE meeting was held at CERN on 12 July 2014.

ULICE was an EC-funded infrastructure project under the umbrella of the European Network for Light Ion Therapy (ENLIGHT) and co-ordinated by the Italian National Centre for Oncologic Hadrontherapy (CNAO). It brought together 175 members from 20 European institutions including all existing and planned therapy centres, two research centres (CERN and GSI), and two leading industrial partners (IBA and Siemens). The project consisted of the following three pillars covering activities ranging from standardization of medical protocols in hadron therapy to studying the radiobiological effects of different ion beams on tumours and normal tissue.

Networking Activities (NA)

Co-ordinated by CERN, the NA pillar's main aim was to increase co-operation between facilities and research communities wanting to work within the research infrastructure. The NA pillar was responsible for the internal communications among its consortium members as well as for reporting on the project's activities outside the consortium. A number of flyers were produced, articles were written, presentations were given at international conferences and a video was produced to promote beam time available within the project.

More recently, as part of the dissemination activities of ULICE, an interactive map communicating major aspects within an ion-therapy facility was set up. This makes a wide range of content related to the subject, such as photos, videos and web links, accessible in an intuitive way (see www.cern.ch/virtual-hadron-therapy-centre).

A Training and Education Committee (TEC) was set up in 2009 with a representative from each of CERN, CNAO and the European Society for Radiotherapy and Oncology (ESTRO) to provide travel grants for course and workshop attendance and to facilitate exchange visits. Some of the courses covered within the ULICE framework have included:

- Radiotherapy with protons and ions held in Uppsala, Sweden, in March 2012. Among the 56 participants, 3 were junior scientists from the consortium supported by ULICE grants.
- Radiotherapy with protons and ions held in CNAO, Italy, in March 2013. There were 58 participants, 4 of them junior scientists from the consortium supported by ULICE grants.
- Clinical practice and implementation of image-guided stereotactic body radiotherapy held at Wurzburg, Germany, in September 2012.

The course on radiotherapy with protons and ions provided knowledge on treatment planning, dosimetry, treatment delivery and the latest technological developments. It targeted radiation



The ULICE group at the final meeting at CERN in July 2014

oncologists and radiation physicists in addition to being open to the general public.

The NA pillar was also responsible for organizing five annual workshops at different locations around Europe, which were attended by over 100 participants each year, bringing together the ULICE consortium and other members of the ENLIGHT community.

Trans-National Access (TNA)

The TNA pillar took a two-step approach and was responsible for providing beam time using a combination of pre-defined clinical-trial programmes to allow researchers to visit the facility and for radiobiological and physics experiments to take place.

Within the ULICE project, there were two access providers – CNAO in Italy and the Heidelberg Ion-Beam Therapy Centre (HIT) in Germany. CNAO has been operational since 2010 with three treatment rooms and one experiment room. It has a synchrotron for protons (60-250 MeV) and carbon ions (400 MeV/n). During the last phase of the project the budgeted number of hours was provided mainly for preclinical research projects.

Beam time was promoted in several ways: through a video that was shown at main scientific events related to ion therapy, publications, announcements on the project's public website, communications to the International Atomic Energy Agency (IAEA) and others. The co-ordinator, via several messages to beneficiaries, communicated availability of beam time for research activities within the consortium. Ten applications were received and evaluated by a selection panel. In order to guarantee transparency in the selection procedure, the selection panel had both internal and external members from the two facilities providing access: HIT and CNAO.

In 2012 HIT began the TNA activities providing beam time to two groups of researchers who had been working on detectors for radiation. Research groups consisted of young researchers of seven different nationalities brought together by ULICE. The last phase of the project saw many research groups visit CNAO from January to August to use beam time. Their main goal was to test the instruments in development, to gather hands-on experience

in radiation measurements and to develop long-lasting networks with experts in radiation detection around the world. Both proton and carbon-ion beams were used for more than 35 hours.

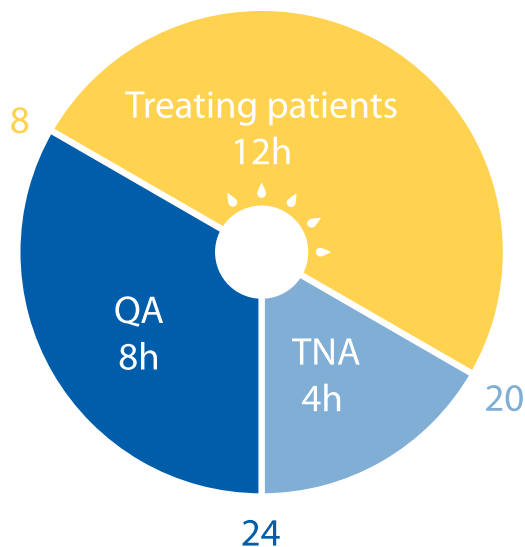

Beam time for TNA at CNAO on weekdays (24h on weekends)

Clinical Trials: The ULICE-generated PANDORA-01 trial, jointly designed and set up by HIT and CNAO according to the ULICE workflow to evaluate carbon-ion radiotherapy for the treatment of recurrent rectal cancer, started recruiting patients in December 2012. Phase I is designed to determine the recommended dose of carbon-ion radiotherapy for recurrent rectal cancer, while Phase II will look into the feasibility and progression-free survival after irradiation.

Joint Research Activities (JRA)

This pillar focused on the development of research infrastructure, instruments and protocols and the promotion of specific research activities. Six work packages were designed to meet these challenges and they addressed the following topics:

Clinical research infrastructure: The aim of this work package was to optimize the use of available ion-therapy centres and improve the development and design of future facilities. Activities included development of ion-therapy joint concepts and terms for dose-volume and outcome assessment, development of standard operation procedures for clinical-trial design, clinical research infrastructure and innovation tools.

Biologically-based expert system for individualized patient allocation: This work package was set up to develop a novel radiobiologically-driven software prototype to help in patient-selection based on individual biological features of the specific tumour, including stages and biology of treatment with different types of beams (photons, protons and ions). It was also responsible for the development of a database with systematically-collected prospective and retrospective clinical and radiobiological data analysing the value of hadron beams on different tumour types.

Ion therapy for intra-fractional moving targets: This work package was involved with the establishment of 4D imaging, deformable image registration and motion modelling with a precision that is sufficient for particle-therapy treatment planning and delivery. It developed a motion monitoring system that can provide precise target position information on a timescale of milliseconds together with a tracking-system prototype for CNAO and workflow concepts including radiation protection aspects for 4D ion radiotherapy. It also implemented rescanning functionality at HIT.

Adaptive treatment planning for ion radiotherapy: Dose delivered to a patient during treatment might differ from the planned dose because of organ motion, dynamic changes in tumour biology or set-up accuracy. This has an impact on the quality of radiation therapy delivered to the patient. Adaptive treatment planning uses knowledge about the patient or specific tumour alterations to modify and improve treatment. The aim of this work package was to provide methods, protocols and software for adaptive ion therapy, taking into account treatment parameters that vary rapidly in time and location. Variations in radiosensitivity, anatomy and topography were addressed. Different beams of radiation and their associated radiobiological efficiency for healthy and tumour tissue were studied.

Carbon-ion gantry: This work package analysed the various aspects that influence the design of a gantry for carbon ions. Mechanical, functional and technological issues were considered in producing a conceptual design that controls costs without significantly limiting functionality.

Common database and grid infrastructures for improving and catalysing access to RI for the broad European community: This work package has established a framework of IT services to support data-sharing and semantic inter-operability across the entire project and with existing cancer grids, enabling the project to achieve maximum impact in the shortest possible time and at minimum cost. Services were developed for case referral, scheduling and treatment management, using architectures that facilitate privacy, anonymity and security. Support was provided for the development of common multilingual vocabularies, data items, protocols and workflows to facilitate data-sharing across the entire European ion-therapy grid and to facilitate statistics on health economics. The final aim was to improve future European decision making, operational efficiency, quality assurance, data analysis, publication of results and teaching opportunities in this area.

More information: cern.ch/ulice

Project co-ordinator: Roberto Orecchia (CNAO)

Co-funded by the EC within the FP7 Capacities Programme, under Grant Agreement No. 228436.

ENVISION

Accurate positioning is a crucial challenge for targeting tumours located in moving organs and for adapting the irradiation as the tumour shrinks with treatment. Therefore, quality assurance becomes one of the most relevant issues for an effective outcome of the cancer treatment. ENVISION was proposed and funded by the EC in order to improve the quality assurance tools for particle therapy. Launched in February 2010, ENVISION is a collaboration of 16 leading European research centres and industrial partners. The initial duration of 4 years was extended by 6 months, bringing the project to its end in July 2014. The project, divided into specific work-packages (WP) in order to tackle specific points, aimed at developing solutions for real-time, non-invasive monitoring, quantitative imaging, precise determination of delivered dose, fast feedback for optimal treatment planning, real-time response to moving organs and simulation studies.

Time-of-flight in-beam PET

This WP focused on in-beam imaging of the positron-emitting isotopes produced during therapeutic exposures to ion beams. The aim was to improve image quality, limiting the region of interest with a measurement of the time difference between the photons emitted by positron annihilations in the body (time-of-flight positron emission tomography, TOF-PET). Recent developments have achieved TOF resolutions approaching 200 ps, corresponding to a resolution in the body of a few centimetres, with substantial improvements in image quality, Compton-scatter rejection and artefact reduction.

Within the ENVISION programme, two detector concepts have been tested. The first approach, closely following the mainstream implementation of commercial PET instrumentation, makes use of arrays of high-atomic number scintillating crystals coupled to fast scintillation photon detectors and recording electronics. Several alternative choices have been tested and analysed to select the most promising crystals in terms of light yield and fast response. Thorough optimization work allowed maximization of the light yield and response of multi-crystal arrays, leading to the construction of a demonstrator set-up.

A less conventional approach capitalizes on the development of a family of ultra-fast gaseous detectors, the multi-gap resistive plate chambers (MRPCs), widely used in high-energy physics for sub-nanosecond timing of charged prongs. The application for detection and timing of 511 keV γ -rays has required the development of dedicated simulation programs to assess the detection efficiency and a comparison with experimental results. A twin-head demonstrator resulted in a coincidence-time resolution (CTR) of 550 ps FWHM. This is short by a factor of two of the proposed target, but compares with existing crystal-based commercial instruments. The major advantage of MRPCs lies in the possibility of achieving low-cost, large angular coverage.

The hardware developments have been guided by and continuously adapted to the results of extensive model calculations and simulations describing the performances of



Prompt-gamma camera developed within ENVISION for real-time monitoring of the dose delivered to the tumour

complete arrays of detectors, both for the crystal and the RPC approaches. Extensive simulation work, both with Monte-Carlo-generated therapeutic beams and with real patient data have permitted discovery of the most effective image reconstruction algorithms, in order to take full advantage of the sub-nanosecond TOF information in removing artefacts and improving knowledge of the exposure dosimetry.

In-beam single particle tomography

The objective of this WP was to investigate the feasibility of applying irradiation components that promptly follow nuclear reactions between the particles of therapeutic beams (protons or light ions) and the atomic nuclei of the irradiated tissue for real time in-vivo dosimetry during proton and ion therapy. These radiation components comprise γ -rays, neutrons and light charged particles (e.g. protons and γ -particles). The main focus has been on the use of prompt γ -rays for in-vivo dosimetry with the goal being to establish a single-photon-emission computed tomography (SPECT) for integration into the treatment workflow at hadron-therapy facilities. This method is generally referred to as prompt γ -ray imaging (PGI), or in-beam SPECT (ibSPECT), if tomographic methods are applied. In this framework, prompt γ -ray imaging techniques and algorithms have been developed; these are capable of determining primary particle ranges in-vivo during therapeutic irradiation with an accuracy of a few millimetres, thus meeting the requirements of particle therapy for controlling the particle range. One passively collimating γ -camera has reached a high development status that allows the clinical evaluation of this system to begin, in addition to evaluation of the clinical potential of prompt γ -ray imaging for quality assurance in particle therapy. This WP also assessed the feasibility of using secondary protons to deduce the range of the primary ions with clinically-required accuracy, via the method of interaction vertex imaging.

Particle therapy in-vivo dosimetry and moving target volumes

Positron emission tomography (PET) still represents the only clinically available technique for in-vivo non-invasive monitoring of the ion-beam delivery and range during or shortly after the radiotherapy treatment. Methods for in-vivo treatment verification

are urgently needed for tumour entities subject to unrestrained physiological motion, to confirm safe and conformal application of a moving ion beam (for state-of-the-art scanning delivery) to a moving anatomy.

This WP aimed to assess the feasibility and enable optimal performance of time-resolved in-vivo dosimetric imaging for validation of motion-mitigated ion-beam delivery to moving targets. The high potential of motion-compensated PET was assessed, not only in terms of lateral field position and beam range confirmation, but also with respect to the possibility of identifying motion-induced interplay effects. However, analysis of the data at realistic low counting scenarios indicated the need for noise-robust reconstruction and counting-statistics optimization strategies. A dedicated 4D MLEM algorithm has been developed and demonstrated for the dedicated in-beam PET scanner at GSI. For the commercial offline PET/CT scanner at HIT, the initial clinical investigations had to rely on the only available reconstruction strategy of gated PET, where the poor counting statistics are further subdivided into four to eight motion phases. Despite the challenges owing to a reduced number of true counts emerging from a less confined region of activation, irregular respiratory motion and activity washout due to biological processes, the feasibility of 4D offline PET-based treatment verification under clinical conditions was demonstrated. In particular, the benefit of taking into account the target motion was demonstrated for patient cases with comparably high numbers of true counts (above 600,000) and superior-inferior motion amplitudes in the order of 10 mm. The drawbacks of low counting statistics and severe biological clearance could be overcome by future dedicated in-beam PET prototypes, such as those developed within another ENVISION WP.

Algorithm-development activities were directed towards the implementation and testing on phantom and clinical datasets of a motion-aware 4D maximum likelihood reconstruction strategy for PET-based treatment verification in ion-beam therapy. This provides a three-dimensional comparison between the measured PET and the expected PET, which is derived from a Monte Carlo (MC) simulation of treatment delivery. The aim was to provide higher robustness and accuracy compared to the mono-dimensional analysis based on the analysis of distal fall-offs of PET activity profiles along the beam direction. The biomechanical approach for motion-compensated PET image reconstruction based on tetrahedral meshes and finite element modelling accounting for motion and deformation, has been further developed and tested on clinical data sets (lung and liver cases). Results provided evidence of comparable reconstruction accuracy for static targets and increased correlation with respect to reference MC activities when small and large motion and deformation were added into the simulations. Translational research activities focused on prompt- γ imaging for quantitative assessment of range uncertainties in the presence of motion. These studies revealed a potential significant role of prompt gamma detection in clinical scenarios for online range verification.

The combination of in-vivo dosimetry, treatment planning and clinical relevance

PET is the only clinically applied technique to monitor particle therapy in vivo. To facilitate the comparison of predicted and measured activity distributions, software was written for automated detection of treatment-delivery deviations that can provide the basis for adaptive ion-beam therapy, i.e. to modify the treatment plan for subsequent treatment fractions, ensuring that the dose delivery is as close as possible to what was prescribed.

Two approaches were developed in parallel. The first approach was based on the analysis of the distal fall-off of the activity distribution, which contains all necessary information for a full 3D evaluation of the in-beam PET data. The second method for the semi-automated comparison was based on statistical assessments in a predefined region of interest, using Pearson's correlation coefficient (PCC) to detect ion-beam range deviations. Both algorithms were validated on 12 in-beam PET studies at GSI of skull-base tumour patients. Sensitivity and specificity of both methods were evaluated and found to provide similar results. Both methods are thus promising and effective approaches to improve the accuracy and efficiency in the clinical workflow, and can be regarded as complementary. The first may be advantageous for initial evaluation, while the second is more appropriate for in-depth analysis. In addition, the PCC-based PET image comparison was successfully tested for detecting patient set-up errors in carbon-ion therapy.

Two customized phantoms were developed and irradiated with ^{12}C beams at the GSI facility and respective PET images were recorded by means of the PET system, for objective testing and verifying of the algorithms for automated comparison of PET images. Preliminary tests indicated that the two methods above can also be applied to automated comparisons of SPECT images. After detailed literature searches, special phantoms have been constructed for detailed ion-beam dosimetry studies. Some contain tissue inhomogeneities (air and several different soft and bone tissues), moving targets, regions to place a Roos ionization chamber and/or a stack of Gafchromic EBT3 films for 3-D dose distribution analysis and can be used for scanned ion beams. A further phantom contains a movable optical system including a camera and an organic scintillator screen in water, where light emission in real time can be imaged.

Radiobiological modelling studies have shown that particle therapy is not as robust as photon therapy when severe deviations of dose placement and inappropriate allocation of relative biological effectiveness (RBE) occur. Methods for correcting errors in treatment delivery, using changes in linear energy transfer (LET), radio-sensitivities and RBE within biological effective dose (BED) equations have been used in worked examples of errors. These are naturally more complex than photon-based corrections, but allow such corrections to be made rather than applying what may be very erroneous corrections by physical dose with complete disregard to the radiobiological consequences. These issues have important implications for clinical-trial design and informed patient consent.

Analysis of the 'Rococo' database at the Maastricht clinic of prostate-cancer patients with inclusion of prostate motion between fractions has been extended to patients re-planned for best photon, proton and carbon ion beams, with reasonably good predictive accuracy for known patient biochemical control outcomes. Stability of treatment is improved by image guidance and daily dual-field treatment is predicted to be superior to daily single-field treatment in intensity modulate forms of proton and carbon-ion therapy.

Monte Carlo simulation of in-vivo dosimetry

MC simulations are an essential tool in particle therapy and in imaging-based particle therapy monitoring, as they can describe the complex physics of ion interactions and at the same time, describe complex geometries, provide accurate multi-dimensional transport and include fully detailed descriptions of the patient anatomy.

Within this WP, various ENVISION research groups have used MC simulations to investigate different aspects of detector design, imaging protocol optimization and treatment monitoring. The main aim has been that of developing dedicated simulation tools appropriate for use in hadron-therapy applications to predict reliably and understand all possible signals useful for treatment monitoring. This activity capitalized on pre-existing developments by different groups, mostly working with GEANT4/Gate, FLUKA and MCNPX simulation codes. The ENVISION work programme on MC simulation tools focused on three main aspects. First, the accuracy of the physics models included in MC codes and involved in particle therapy applications has been investigated. ENVISION has made available a unique compilation of results obtained using FLUKA, GEANT4 and MCNPX codes for the modelling of the physics involved in hadron-therapy experiments, providing a reference document for all those involved in MC simulations of hadron-therapy experiments.

Second, code features have been enhanced so as to improve their accuracy, provide software supporting the modelling of the complex geometries involved in hadron therapy and allowing for the joint modelling of a particle-therapy treatment with an imaging acquisition within the same framework. This brought a set of examples, available to the community, where all steps from treatment to secondary-particle detection, are accounted for. An important effort has been devoted to assess the accuracy and usefulness of these codes, to develop their relevant physics models and ancillary tools and to make them user-friendly and widely available. Third, the use of the code has been optimized so as to become more suitable for the direct application to actual clinical cases and to match, as far as possible, the requirements in terms of reliability, ease and speed of operation.

More information: cern.ch/envision

Project co-ordinator: Manjit Dosanjh (KT Group)

Co-funded by the EC within the FP7 Cooperation Programme, under Grant Agreement No. 241851.

ENTERVISION

The European Training Network in digital medical imaging for Radiotherapy (ENTERVISION) was established in February 2011 to reinforce research in online 3D digital imaging and to train professionals in the early detection and more precise treatment of tumours. This is an interdisciplinary and multinational initiative bringing together ten academic institutes and research centres and a leading European company in particle therapy.

One of the main aims of the ENTERVISION project is to provide multi-disciplinary training to researchers. Over the past 4 years this training programme has covered many varied topics, including basic training on treatment with ions, leadership development and a course on electronics and detectors. The most recent courses took place at IBA (Louvain-La-Neuve, Belgium) in October 2013 and at CERN in July 2014.

At IBA, the researchers were given an opportunity to have an 'inside view' of the industrial partner in the ENTERVISION project. The course covered topics such as R&D lifecycle, patents and intellectual property (IP), supply chain, the role of quality assurance, and therapy centre and patient treatment-system architectures. The researchers also visited the production hall and listened to a presentation about the C230 cyclotron.

At CERN, the researchers followed a CV-writing and interview-technique course, helping them to look beyond the project (which finishes in January 2015) and to prepare for their future careers. The course taught them how to position their career, market themselves and the art and craft of answering interview questions. Members of the IP section at CERN presented interesting case studies on business models and patents and were available to answer any questions relating to IP and patents. The course at CERN was followed by the annual ENTERVISION meeting along with the final meetings for both ENVISION and ULICE. ENTERVISION researchers won two of the three CERN KT poster prizes awarded at the meetings.



The ENTERVISION researchers at CERN in July 2014

ENTERVISION research is organized into four clusters: unified hardware and software solutions for signal handling, data acquisition and processing for image-based in-vivo dosimetry; modelling of in-beam PET and SPECT devices; nuclear-fragmentation studies and integration of treatment-related imaging and dosimetry data.

Data acquisition systems provide input ports where the signal is digitized and time stamped. Work in the first cluster includes the development of a real-time signal and reconstruction interfaces for semiconductor detectors for Compton cameras and in-beam TOF-PET to measure the beam position. PET block detectors are characterized, tested and analysed at different accelerators to compare performances and assess the choice of absorber for the Compton camera. Geant4 is used to drive the choice of samples and geometry. A new generation of multi-gap resistive-plate chamber detectors are being investigated and their firmware is being developed. There is development work on a three-layer dose-monitoring Compton telescope prototype, with each layer made of continuous LaBr₃ crystals coupled to silicon photomultiplier arrays. The prototype has been built and is being tested. This cluster also works on the development of a prompt- γ camera and a comparison between parallel-slit and a knife-edge slit collimator configurations.

Modelling based on simulations is of crucial importance at all stages of an imaging system. Researchers continue the development and validation of physics models for production, transport and detection of positron emitters and associated photons. Nuclear interaction models within Geant4/GATE and FLUKA are being studied, to enable development of Monte Carlo applications in specific problems related to ion therapy and monitoring. Two possible models have been identified to describe quasi-elastic breakup of carbon ions, and data have been simulated and analysed. Work is also on-going on speeding up simulation of PET and SPECT for hadron-therapy monitoring. Models of in-beam physical processes that lead to prompt- γ emission need to be benchmarked against experimental data and tested in realistic cases to make the link between research and clinical practice. Besides prompt- γ radiation, the emission of light, charged particles may be regarded as an efficient way to provide real-time information on dose deposition during carbon-ion therapy. The nuclear fragmentation cluster works on experimental studies to investigate characteristic features of secondary particles produced along the path of the primary therapeutic ion beam. Since current experimental data are scarce, the experimental programme consists of making measurements of differential cross-sections for the production and transport of light particles in the context of ion therapy. High-energy light-ion beams from GSI are being used for the experiment.

The cluster on treatment integration deals with issues relating to the safe and effective implementation of image-guided, biologically-optimized radiation therapy. One of the researchers is investigating the impact of parameters on dose delivery, target coverage and homogeneity to allow recovery for dose-delivery errors caused by intra- and inter-fraction motion. The influence of motion is evaluated through radioactive-source experiments and a comparison of 4D PET images. A phantom that can accommodate cell cultures has been developed to provide biological and physical dosimetric outputs. Irradiation tests are performed at HIT and CNAO. Work is on-going on the development of near-real image processing techniques for segmentation, tracking and micro-beam targeting of cells using bright-field illumination microscopy. Software is being developed to recognize, track and target individual cells.

ENTERVISION researchers have a generous travel allowance that allows them to attend conferences and workshops throughout the year, travelling as far as Japan, China and Korea. Many of them are gaining valuable experience presenting posters and publications. At ICTR-PHE held in February 2014 in Geneva, four of them presented posters and six gave oral presentations. The training that the researchers have undertaken during their time in the ENTERVISION project will help enhance their skills portfolio and make them highly employable scientists with not only the necessary technical skills but also valuable 'soft' skills. The final meeting will be organized in Rome in January 2015. At the meeting, the researchers will share the progress of their research projects and celebrate together the end of another successful project.

More information: cern.ch/entervision

Project co-ordinator: Manjit Dosanjh (KT Group)

Funded by the EC within the FP7 People (Marie Curie) Programme, under Grant Agreement No. 264552.

Communication and outreach

The LS Section has long-standing experience in communicating topics related to medical applications of particle-physics technologies to political stakeholders, members of the press and the public at large. In 2014, the section also supported the communication activities of the new CMA office.

For the ICTR-PHE conference, a press briefing followed by a visit to CERN and free access to the conference was organized; this resulted, among other articles, in a 'Talking Point' feature on Medical Physics Web in February. As for the previous edition, a conference blog was set up and the public talk was webcast. Close collaboration with the CERN Communication Group allowed for further diffusion of the information through social media and articles on CERN media.

Much work was done to promote the EU projects co-ordinated by the section, including: an article in the May issue of *CERN Courier* detailing the achievements of the PARTNER Marie Curie researchers; a web-based interactive map of a virtual hadron-therapy facility sponsored by ULICE; a 3D animation to explain hadron therapy from the patient's viewpoint sponsored

by ENVISION; participation and sponsoring of the European Researchers' Night by ENTERVISION and a January issue of ENLIGHT Highlights.

A major international event of the year was EuroScience Open Forum (ESOF) 2014, where the LS and CMA activities were promoted by the LS section leader who moderated a session on cancer detection and treatment and, together with CERN's Director for Research and Scientific Computing, Sergio Bertolucci, and former CERN Director-General, Chris Llewellyn Smith, also participated in an EIROforum-organized session entitled 'Decoding the origin, fabric, and fate of life and the Universe'. The LS section leader was also interviewed by the BBC for its Horizon series.

The communication effort for the CMA was targeted at promoting the new series of Medical Applications Seminars and at raising awareness (both within and outside the Laboratory) of the actions implemented.

Detectors and accelerators for medicine

PicoSEC-MCNet

PicoSEC-MCNet (Picosecond Silicon-photomultiplier Electronics and Crystal research – Marie-Curie Network) – a Marie Curie Training Programme under the auspices of the EC – is entering the final year of its 4-year-long curriculum. Anchored in an ambitious pioneering research project that addresses new developments in time-of-flight positron emission tomography (TOF-PET) and future high-energy physics calorimetry, it has become home to 18 early stage researchers (ESRs) and 4 experienced researchers (ERs) from as many as 15 nations worldwide (Argentina, Bulgaria, China, Cuba, France, Greece, Hungary, Italy, India, Iran, Israel, Latvia, Lebanon, Poland, Spain).

Hosted by seven public-research and four private-sector network partners located in six European countries, these highly motivated researchers have become true experts not only in the fields of scintillation phenomena, optics and photodetectors, but also in a wide range of applications for ultrafast timing, electronics and data acquisition. With both the research and training activities reaching the final phase of the project, detector integration and prototyping, PET image reconstruction and tracking-navigation finally supplement the basic educational training modules. Owing to regular secondments to partner facilities, researchers had – and still have – a chance to widen their scope, both scientifically and intellectually, particularly pursuing activities in dissemination and outreach.

Gradually closing the scientific part of the project, the network continues to live up to its educational mission to reach out globally, publicizing its rich portfolio of scientific discoveries at major international conferences and workshops. With such a record of scientific and scholarly success, this Marie Curie Programme will remain in the hearts of all people involved,

underlining the collaborative spirit among the partners and the generous patronage of the EC.

More information: cern.ch/picosec

Project co-ordinator: Etienne Auffray (Physics Department)

EndoTOFPET-US

The EndoTOFPET-US collaboration aims to develop early detection for pancreatic and prostate cancers through molecular diagnostic tests. The EC/FP7-funded project is developing a novel multimodal device for ultrasound (US) endoscopy and PET for detecting and quantifying novel morphologic and functional biomarkers for pancreas and prostate oncology. CERN is responsible for the technical co-ordination of the project, which involves a team of 13 European partners, including three university hospitals and three companies.

The core of the endoscopic probe in the EndoTOFPET-US project is a large-format multi-channel digital silicon photomultiplier (SiPM) coupled with a 9×18 array of $0.71 \times 0.71 \times 15$ mm³ LYSO:Ce scintillators developed and assembled at CERN. The chip comprises 9×18 digital SiPMs, each composed of 416 pixels and capable of recording up to 48 time stamps from individual scintillation photons produced by each γ conversion in the crystal array. This miniaturized PET probe is mounted on two commercial ultrasound endoscopes, one for the pancreas and one for the prostate.

The coincidences are made between the endoscopic probe and an external plate, which is made of 256 modules composed of 4×4 matrices of LYSO scintillating crystals, each with a size of $3.5 \times 3.5 \times 15$ mm³ coupled to TSV-MPPC (4×4) arrays from Hamamatsu (S12643-050CN), with a cell size of 3×3 mm² and a pitch of 3.6 mm.

The objectives of the TOF-PET system are to reach a coincidence-time resolution of 200 ps FWHM (three times better than the state of the art) and to provide spatial resolution of better than 1 mm.

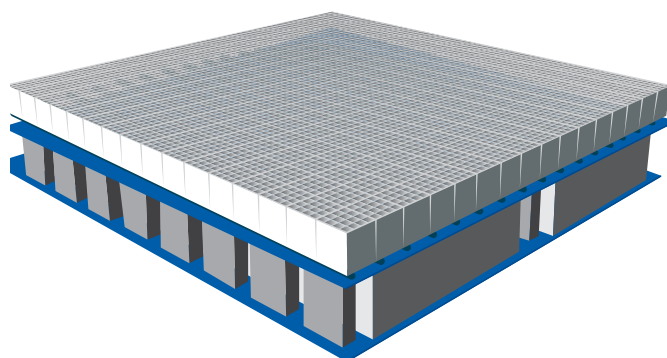

EndoTOFPET-US external plate

The prostate version of the EndoTOFPET-US project was fully commissioned at CERN at the end of 2014 and will be delivered to the European Center for Research in Medical Imaging (CERIMED) in Marseille for the first preclinical tests on pigs xenografted with pancreas and prostate tumours.

*More information: cern.ch/endotofpet-us
Project co-ordinator: Paul Lecoq (Physics Department)*

ClearPEM-Sonic

The ClearPEM-Sonic project aims to develop dedicated breast-imaging PET for early breast cancer diagnosis. Breast cancer is the most frequent cancer among women and accounts for up to 23% of all cancer cases in female patients. A female patient's risk of contracting it during her lifetime is around 10%, based on life expectancies of 70-90 years. Survival rates are very high as long as it is detected at an early stage, is still sufficiently small and has not spread to lymph nodes or started to metastasize.

CERN launched an ambitious programme on molecular breast imaging in 2001 in the framework of the Crystal Clear collaboration, which has led to the construction of the ClearPEM, a dedicated breast PET scanner (the first PET device using avalanche photodiodes that were developed for the electromagnetic calorimeter of the CMS experiment) and of the ClearPEM-Sonic, a new generation of ClearPEM coupled to the novel ultrasound AIXPLORER system with automatic user-independent elastography capability developed by the company Supersonic-imagine in France. This system has undergone first clinical evaluation on a group of 10 patients at the European Center for Research in Medical Imaging (CERIMED) in Marseille, where its millimetric spatial resolution and very high sensitivity have demonstrated a major breakthrough, as compared to the

state of the art. As a result of this the ClearPEM-Sonic was moved to the San Girardo hospital in Milan and commissioned in 2014. There, a more ambitious clinical evaluation will be performed in 2015 on the basis of 200 patients and a comparison of FDG (fluorodeoxyglucose) and FLT (deoxyfluorothymidine) as biomarkers for cell-energy consumption and cell proliferation, respectively.

Meanwhile in 2014, CERN launched a programme in collaboration with the Portuguese company PETSys (a spin-off of the ClearPEM project) to develop a new generation of PET detector modules based on SiPM and light-sharing between crystals for better performance and a more cost-effective version of the ClearPEM.

Also in 2014, CERN initiated the PENELOPE project for a bi-modal PET-MRI system based on a new improved generation of ClearPEM (including the photonic crystal capabilities) and a low-field MRI system developed by the Italian company PARAMED, coupled to a stereotactic biopsy system. The aim is to combine the high resolution (but low specificity) of MRI with the high molecular sensitivity of PET to guide the biopsy to the metabolically active parts of the tumour. This project, regrouping a consortium of 13 institutes including 4 hospitals, was submitted to the EU HORIZON2020 programme in October 2014.

*More information: cern.ch/crystalclear/pemsonic.html
Project co-ordinator: Paul Lecoq (Physics Department)*

CERN-MEDICIS

The CERN-MEDICIS project is an ambitious initiative that has been set up to deliver novel radioisotopes for research and clinical therapy. It was initially supported via the KT Fund in 2011/12, which catalysed project expansion. In 2014, the project was selected as part of CERN's new medical applications programme (CMA) to receive further funding and support.

A number of important milestones were achieved in 2014. In particular, the dedicated CERN-MEDICIS building was constructed and the soil put back in place to allow for the restart of the ISOLDE facility. The first section of the rail conveyer system and the target irradiation station in the High Resolution Separator dump were installed during the long shutdown LS1. The system was commissioned with a first MEDICIS target-unit prototype under proton beam irradiation. Monitoring of the operation parameters such as secondary beam production at ISOLDE and stray radiation fields confirmed that the system can be operated as foreseen in its design. Other important achievements included: selection of the building ventilation system; procurement of various key mechanical systems, such as the shielded doors; and the design of the controlled-access system. The next important phase in the project will be the timely installation of the ventilation system, compatible with the existing ISOLDE facility.



The ClearPEM-Sonic installed at CERIMED

In addition, a one-day workshop held on 15 October featured presentations from invited speakers involved with the project. Talks covered topics ranging from technical advances, through safety and preclinical studies, to the recently successful EU Marie Curie ITN proposal 'MEDICIS-PROMED'.

Furthermore, a memorandum of understanding was crafted in December 2014, together with the KT Group and CERN Legal Service, which will permit collaborators from research institutions, clinics and hospitals across CERN's Member States to bring their enthusiasm and expertise to this exciting and forward-looking project.

Project co-ordinator: Thierry Stora (Engineering Department)

CNAO

In 2014 the National Centre for Oncological Hadrontherapy (CNAO) in Pavia started the normal running phase with patient treatments recognized by the national health system. At present more than 400 patients, selected within 23 clinical protocols, have completed the treatment. The pathologies are elective for hadron therapy and include tumours close to critical organs that

cannot receive extra doses, or tumours that are radioresistant and thus unresponsive to conventional x-ray therapy. The table below outlines the protocols and the enrolled patients treated at CNAO.

The follow-up period is still too short to give final clinical indications in terms of effectiveness, but the results have clearly demonstrated the safety and reliability of the procedures and very good results in terms of low acute toxicity.

Besides the treatment of fixed pathologies, CNAO has developed, in collaboration with the Polytechnic of Milan, the safest approach to the treatment of moving targets with ion beams: motion-compensated treatments require the availability of real-time breathing-motion detection during treatment, in order to guide actual beam irradiation. This is available at CNAO through the Optical Tracking System (OTS) that continuously monitors the patient during treatment. The first two patients, one affected by liver cancer and one by pancreatic tumour, have recently been successfully treated. Furthermore, a novel eye-tracking system (ETS) prototype for the real-time 3D target-localization and ocular-movement detection has been developed and tested. During the planning of CT acquisition, the ETS can be used to map tumour position in local coordinates,

Protocol description	Ions	TOTAL
Proton radiation therapy for chordomas and chondrosarcomas of the skull base	Protons	47
Proton therapy of spine chordoma and chondrosarcoma (amended)	Protons	16
Proton therapy of intracranial meningioma	Protons	10
Proton therapy of recurrent cervico-cephalic area tumours	Protons	7
Proton boost for locally advanced cervico-cephalic area tumours (amended)	Protons	19
Proton re-irradiation of recurrent spine chordoma and chondrosarcoma	Protons	3
Carbon-ion therapy of adenoid cystic carcinoma of salivary glands (amended)	Carbon ions	70
Carbon-ion re-irradiation of recurrent pleomorphic adenomas	Carbon ions	11
Carbon-ion re-irradiation of recurrent rectal cancer	Carbon ions	3
Carbon-ion radiotherapy for bone and soft tissue sarcoma of cervico-cephalic area	Carbon ions	71
Carbon-ion radiotherapy for bone and soft tissue sarcoma of trunk	Carbon ions	71
Carbon-ion therapy of recurrent cervico-cephalic area tumours	Carbon ions	52
Carbon-ion therapy of malignant melanoma of the mucous of the upper aerodigestive tract	Carbon ions	10
Carbon-ion therapy for high-risk prostate cancer	Carbon ions	6
Carbon-ion therapy of primary and secondary orbital tumours	Carbon ions	6
Carbon-ion therapy for pancreatic cancers	Carbon ions	2
Carbon-ion therapy of primary malignant tumours of the liver	Carbon ions	1
Carbon-ion re-irradiation of recurrent spinal chordoma and chondrosarcoma	Carbon ions	2
Protons and/or carbon-ion integrated radiotherapy for poor prognosis in patients with inoperable sinonasal tumour	Protons / Carbon ions	4
Carbon-ion therapy of pancreatic cancers	Carbon ions	1
		412

thus allowing real-time tumour referencing during irradiation. The picture below shows one of the three treatment rooms at CNAO with the OTS.

In just a few short years of activity, CNAO has acquired an outstanding profile and visibility in the international community of hadron therapy and radiotherapy. In order to enable the consolidation of this position and further enhance it, it is necessary that investments in research and development are assured so as to make it a benchmark of absolute value in a global landscape of growing interest in hadron therapy and ion therapy in particular. The ongoing construction, in collaboration with INFN, of a beam line dedicated to research is a key point in this advancement, because it ensures the possibility of performing preclinical research in multiple sectors, in a completely dedicated area with laboratories, independent access and available beam time. The construction of the new beam line started in summer 2014 and is planned to last for 2 years. The experience developed at CNAO, together with CERN, INFN, GSI and other partners, is fundamental for keeping hadron-therapy centres up-to-date and at the forefront of the fight against cancer.

[More information: cnao.it](http://cnao.it)



The CNAO Optical Tracking System

MedAustron

MedAustron, the Austrian centre for ion-beam therapy and research, made huge progress during 2014. Its completion and thus the first patient treatment are now within reach, expected in late 2015/early 2016.

The year 2014 was dedicated to the commissioning of the synchrotron, the installation of the medical technology and a multitude of safety-related examinations of the facility. In March, the first beam was successfully injected into the synchrotron. Only a few days later the first turn was accomplished and by May a stable beam of more than 500,000 turns was measured. In August the team managed to accelerate the beam for the first time up to 125 MeV. The first extraction occurred in October

and by mid-October the beam was measured in one of the irradiation rooms for the first time – a truly historic breakthrough for MedAustron.

Besides the commissioning work at the accelerator, the medical technology was installed, including the unique patient-positioning system together with the couch-based imaging device, the latter attracting much attention at the ESTRO exhibition in Vienna in spring. In the last few weeks of 2014, beam investigations were performed in the irradiation rooms and tests of the dosimetry equipment, which will be used for the medical commissioning, were carried out. All necessary systems for patient treatment were successfully installed by the end of the year. Furthermore, the clinical version of the proton treatment-planning system and the main parts of the oncology information system successfully passed the installation and interface tests. In November, MedAustron opened its doors to the public for one day: 8000 visitors proved not only the huge interest there is in the institute but also the great significance of the centre for the region and the whole country.

The year 2015 will be a challenging and exciting one for MedAustron: the commissioning of the accelerator will be completed, the medical commissioning and the trial operation of clinic procedures lie ahead and last but not least the filing to the authority for an operation permit and the CE certification of the facility will be tackled.



The MedAustron accelerator complex

FLUKA

FLUKA is a well-known Monte Carlo general-purpose simulation software package for calculations of particle transport and interactions with matter. It has many varied applications in high-energy experimental physics and engineering, shielding, detector design, cosmic-ray studies, dosimetry, medical physics and radiation protection. Although the package originates from almost 50 years ago, the current version of the code has little in common with the original software. The FLUKA development team is very active, constantly improving the code and extending its application to many new areas. It also nourishes

the worldwide FLUKA community by being active in the mailing lists and organizing frequent training events.

Among FLUKA's strengths is the solidity of its physics models and the precision of its output. These qualities of the code have long been appreciated by researchers around the world and in various fields, inside but also outside the high-energy physics community. For instance FLUKA results are included in recommended standards from the International Commission on Radiological Protection (ICRP); FLUKA developments of relevance for the calculation of astronauts' exposure in space have been supported by NASA; leading hadron-therapy centres such as HIT in Germany and CNAO in Italy rely on FLUKA to provide input data and validation of hadron-therapy treatment planning.

FLUKA has also been part of the ENVISON project for the investigation of novel monitoring techniques in cancer therapy with hadron beams (see p. 12). This latter application is currently further pursued with an even more innovative idea, which is the use of radioactive therapeutic beams, for instance ^{11}C instead of ^{12}C , to monitor in real time the beam propagation with a PET scanner. In April 2014, a dedicated project was approved and funded by the KT fund. Initial simulation studies in water phantoms show a significant improvement in the β^+ signature with ^{11}C and ^{15}O beams with respect to ^{12}C and ^{16}O beams, as expected. More realistic simulations, including real patient CT scans, beam configuration from treatment planning, and with the detailed geometry and response of the actual PET detectors, are in the pipeline. The FLUKA developers will also profit from this project to progress further in the modelling of ion-induced reactions. Validation of this work will be provided by the MEDICIS facility.

More and more commercial companies have shown interest in using the code. Recently six companies from four different countries have pursued their requests and a number of them are already FLUKA licensees. Requests from companies active in medical applications and specifically hadron therapy are also more common. Typical profiles of companies in this field are medical hardware developers using the software to design components for their treatment systems or medical software developers designing treatment-planning systems for established hadron-therapy centres.

[More information: fluka.org](http://fluka.org)

Geant4

The Geant4 toolkit allows detailed simulation of particle interactions with matter for a wide variety of particle types and energy ranges, finding applications in the detailed simulation of the LHC experiments as well as in medical and space science. The latest major software version 10.0, released in December 2013, introduced the possibility to run simulations in parallel through multi-threading, thereby allowing exploitation of parallel computing on modern hardware architectures. One major advantage offered by this approach, compared to

other solutions for parallelism, such as multi-processing, is a significant reduction of the amount of memory required. Memory is a limiting factor for some applications such as the simulation of LHC experiments and simulations required in medical physics including radiotherapy. Such simulations are typically carried out using complex geometry set-ups and require high statistical accuracy, both of which demand good use of memory. The latest release of Geant4 provided in 2014 consolidates previous progress in version 10 by considerably improving CPU run-time and reducing by a large factor the memory footprint required by each thread.

An example of Geant4 applied to medical physics — making use of these new features — is in improving proton therapy treatment planning. The physics simulation capabilities provided by Monte Carlo methods over the semi-analytical models used in radiotherapy treatment planning can be used to provide a more accurate, independent check of treatment plans prior to administering them to patients. However, to obtain the requisite statistical precision requires good computational speed and efficient memory use, and without good parallelism such simulations can take many hours. Recent work has used the latest release of multi-threaded Geant4 on computing hardware that employs the CPU co-processors provided by the Intel Xeon Phi platform. The time reduction achieved by using such co-processor systems is a major step forward in bringing Monte Carlo techniques into real-time use for patient treatments.

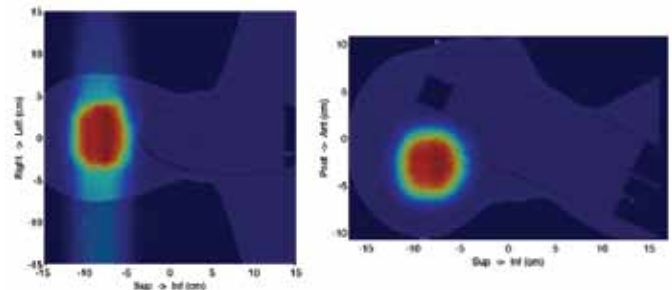

Dose distribution benchmark generated using a mock plan of two opposing uniform dose fields of roughly 1500 sources each, overlaid on the CT image of an anatomical phantom developed at the Christie Hospital, UK. Ten million individual protons are simulated to create a precise dose map that retains a faithful modelling of the relevant physics in the patient. The simulation was carried out on a single Xeon Phi card that ran 244 simultaneous threads to create the dose map in about an hour. Such a calculation was not possible with previous versions of Geant4.

[More information: cern.ch/geant4](http://cern.ch/geant4)

Technology Transfer and Intellectual Property Management

Technologies developed in the scope of the Laboratory's scientific programme often have potential applications beyond the world of high-energy physics. CERN's three core technology domains of accelerators, detectors and information technology serve as fertile landscapes for the creation of novel inventions that – in addition to contributing to the Organizations' scientific mission – offer solutions in fields such as energy, safety, medical diagnostics and therapies, aerospace, industrial processes and consumer electronics.

The figure here illustrates selected key performance indicators for 2014 including the number of patent applications filed, knowledge-transfer contracts signed, opportunities arising outside of CERN (external opportunities), and opportunities arising within the Organization (internal opportunities). The number of external requests and contracts signed have increased on the previous year, by approximately 50% and 30% respectively – demonstrating the continuing demand for support in knowledge-transfer activities, both from inside and outside the Organization. Some of the key activities occurring in the Technology Transfer and Intellectual Property Management Section in 2014 included:



- Continuation of the increasingly popular internal KT Fund for funding promising internal opportunities (see chapter 3)
- On-going support to the rapidly expanding network of CERN Business Incubator Centres (see p.39)
- Organization and attendance at Hannover Messe trade fair 2014 (see p.40)
- Continued interaction and relationship-building with CERN's technical departments via the internal network (INET)
- Organization of two innovation-day events with the Beams and Engineering Departments, which identified a range of new technologies with promising knowledge-transfer potential

The following pages highlight selected projects on-going in the Technology Transfer and Intellectual Property Management Section in 2014, some newly identified and others continuing. They illustrate the impacts of the team's efforts on return to CERN Member States and beyond.

CERN knowledge transfer by type of partner

The figure below illustrates the major types of partner for CERN's external knowledge-transfer opportunities arising in 2014 – universities, laboratories and companies. For each, the top CERN technology domains are shown, corresponding to the size of the surrounding circles. The largest number of opportunities came from companies, followed by laboratories and then universities.

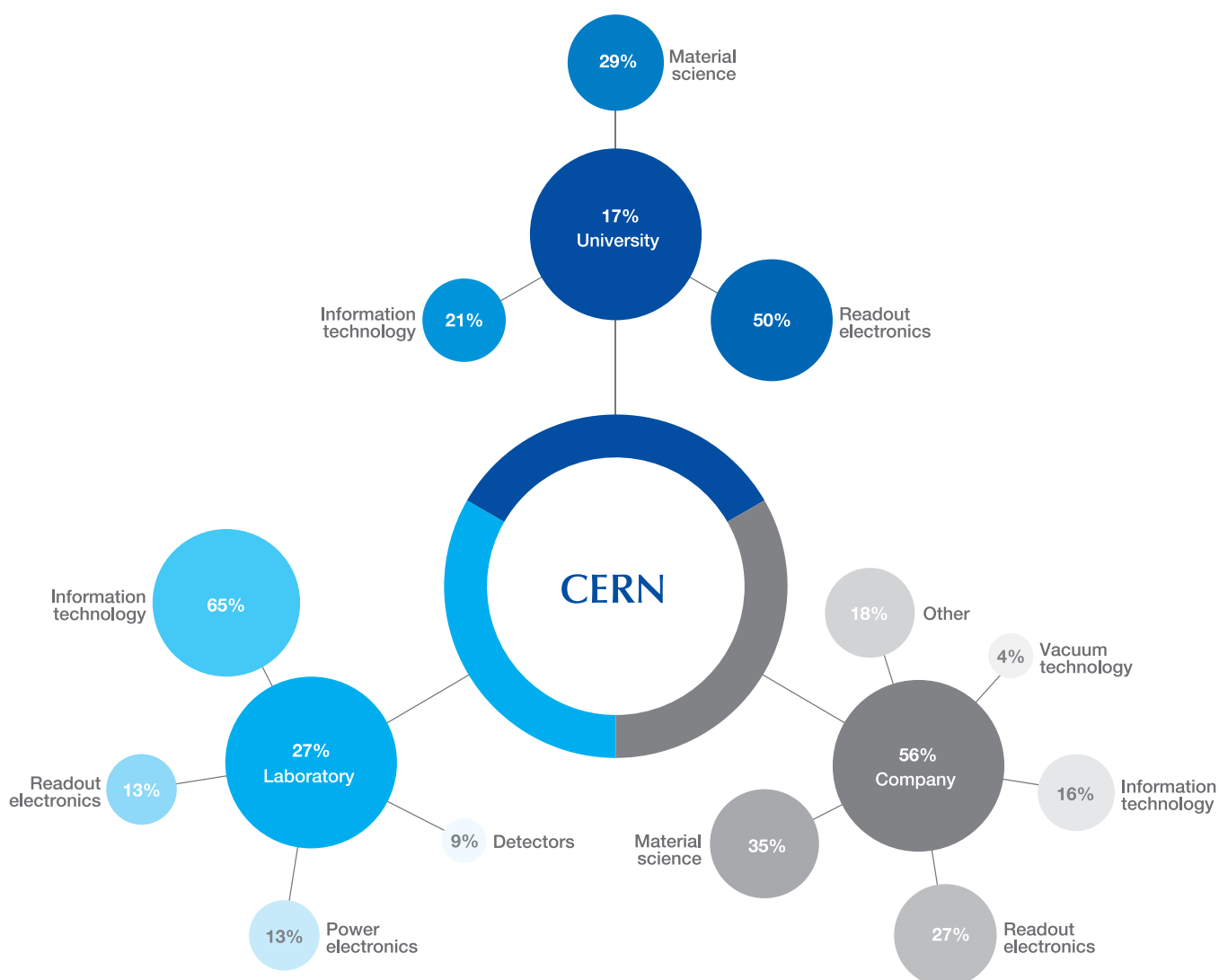

CERN knowledge transfer by application domain

As illustrated by the figure below, knowledge and technologies from CERN's three core technology domains – information technology, detectors and accelerators – are transferred across a spectrum of application domains by the KT Group, in collaboration with CERN personnel. The number one application domain for new opportunities in 2014 was safety, with technologies originating in the main part from information technology and detectors.

The percentages on the left of this figure represent the distribution of all new opportunities arising in 2014 from the three core technology domains. On the right, the percentages show their distribution across the domains of application, and correspond to the height of the bar. The grey shading of the bars represents each of information technology, detectors and accelerators.

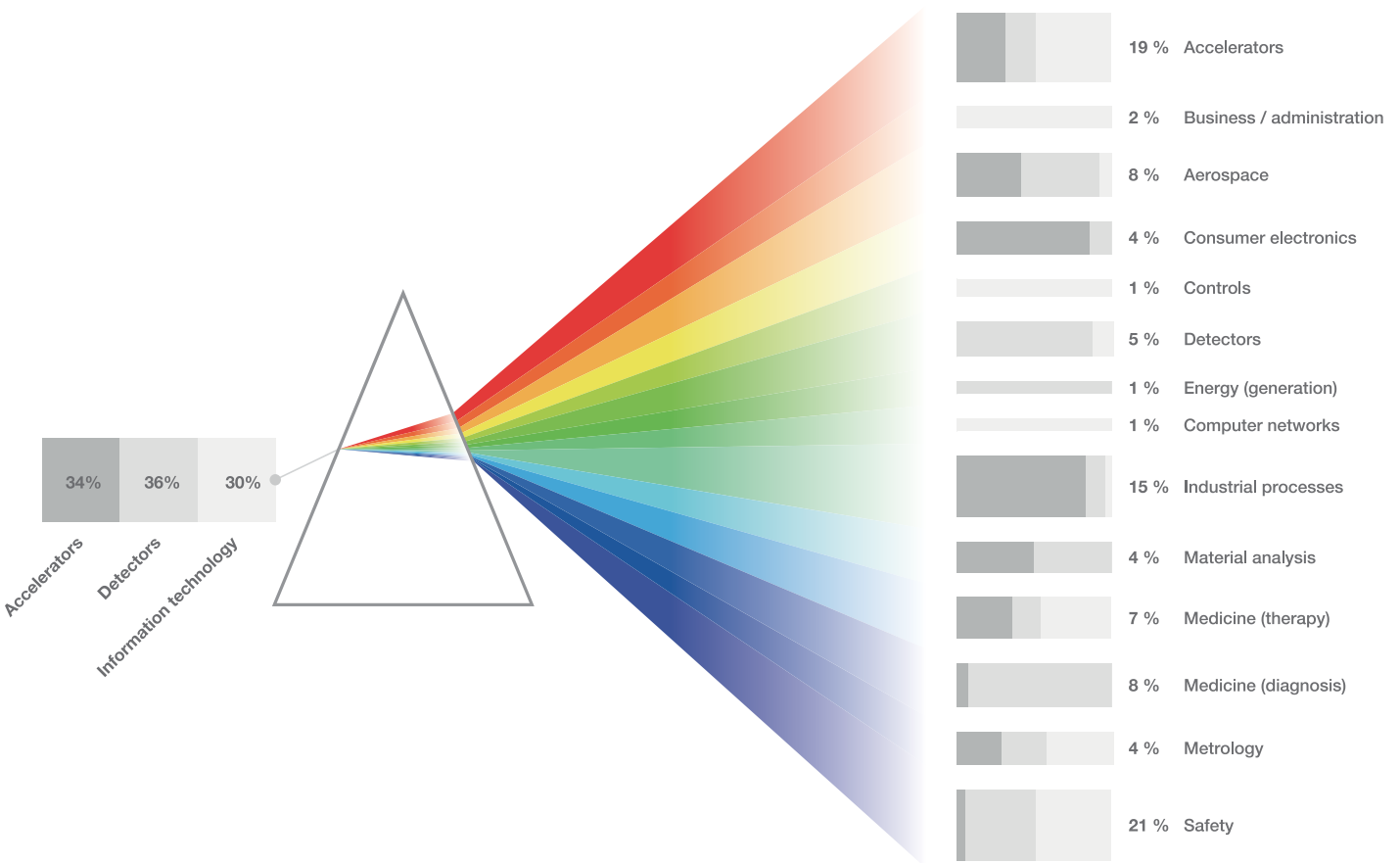

Patent portfolio management at CERN

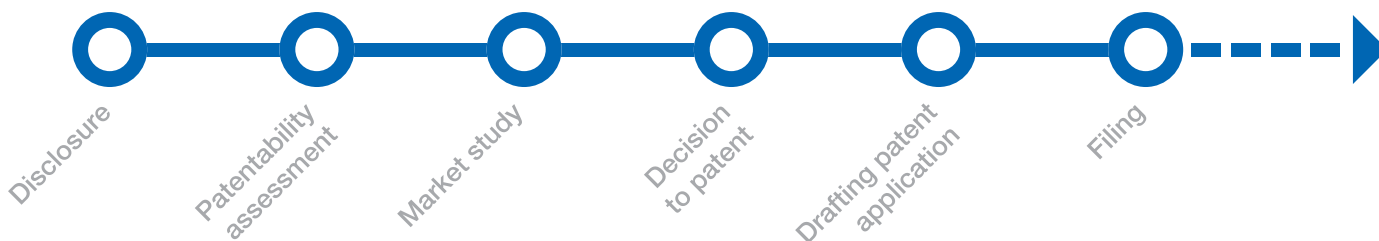

From idea to patent

CERN manages its patent portfolio in accordance with best practices, following a systematic step-by-step approach, from disclosure to filing, with a patentability and market assessment before filing a new patent. A number of changes initiated in 2014 include the production of intellectual property (IP) landscapes, a new supplier for patent and trademark prosecution and a shift to a single service for renewal-fee payment.

In 2014, five new patent applications were filed by CERN or jointly with other institutions, as summarized in the table below.

As a filing strategy, the standard policy is to file first a European Patent (EP) Application from which priority is claimed for filing an International Patent Application (PCT). Exceptionally, a PCT application is filed directly whenever a licensing opportunity already exists at the time of filing in order to receive the search report and written opinion early in the process.

IP landscapes

The patent system plays a role not only in protecting CERN innovations, but also in providing useful market information through patent databases. This information can then be integrated in the decision-making process for knowledge transfer, also for those cases that do not involve patented technology. Indeed, patent information can provide information on:

- Patenting volume in a field of technology
- The main applicants, per sector of activity
- Trends over time and geographical regions

In 2014, patent landscapes were produced in the fields of proton gantries, photolithography light-sources and gaseous particle detectors.

Title	Filing date	Application number	Ownership	Application type
Portable radiation detection device for operation in intense magnetic fields	27/05/2014	EP 14170108.6	CERN, Politecnico di Milano	EP
High-frequency compact low-energy linear accelerator design	15/08/2014	PCT/ EP2014/067512	CERN	PCT
Closed-cycle cryogen recirculation system and method	10/12/2014	EP 14197216.6	CERN	EP
Particle detector with fast timing and high rate-capability	23/12/2014	EP 14200153.6	CERN, INFN	EP
Structuration pour l'optimisation de la collection de photons dans les cristaux scintillateurs et solutions technologiques associées.	13/03/2014	EP 14305365.0	CERN, UTT*, SILSEF, LCMCP*	EP

* Université de Technologie de Troyes (UTT), Laboratoire Chimie de la Matière Condensée de Paris (LCMCP).

Patents

A compact high-frequency RFQ for medical applications

As part of the Medical Applications Programme, a novel type of radio-frequency quadrupole (RFQ) has been designed by a team of scientists and engineers from different departments. The 750 MHz and adapted beam optics make it possible for this RFQ to reach an energy of 5 MeV over a distance of 2 m. It is particularly adapted for applications in hadron therapy. Designed with modularity in mind, the RFQ can also be combined into compact accelerating structures for PET isotope production or technetium production for SPECT tomography. An international patent application was filed in view of the industrialization of this RFQ for medical applications.

Technical contact: Maurizio Vretenar, DG-DI-DAT, Alessandra Lombardi, Beams Department



The B-RAD portable radiation survey meter

for B-RAD in 2014, with a view to licensing the IP. Patent-protected technology is attractive to industry since it helps to consolidate a competitive market position and in this way fruitful knowledge transfer can be achieved.

Technical contact: Marco Silari, HSE Unit



A major vane of the compact high-frequency RFQ, illustrating its compactness

B-RAD

B-RAD is a novel, hand-held radiation survey meter, capable of operating in the presence of strong magnetic fields and simultaneously able to detect a range of radiation including α , β and γ emitters with high sensitivity. The device, as well as being portable, is also very simple to use and is operated in much the same way as traditional instruments like Geiger-Muller or scintillation counters. This makes it a potentially attractive safety-monitoring tool for a variety of applications including: radiation surveys at particle accelerators; medical accelerators (electron linacs including image-guided radiation therapy (IGRT) with MRI imaging); cyclotrons for radionuclide production and hadron therapy; radiation measurements at medical PET/MRI scanners. In addition to non-medical applications, it is also applicable to industrial processing, metal recycling and fire brigade services. Developed by members of the HSE Unit in collaboration with the Polytechnic of Milan, the new instrument consists of two parts: an active probe and a counting unit. First-generation prototype devices have already been produced and the team, in close collaboration with the KT Group, is seeking an industrial partner to help develop second-generation, pre-engineered versions of the technology for manufacture and sale. Discussions are ongoing with several interested industrial parties at the time of writing. Owing to the range of market applications and interest from commercial organizations, CERN sought patent protection

THRAC

When scientists from different fields mix their research the results can be impressive. The Timing and High-Rate Capable Detector (THRAC) is such an example, combining the forces of CERN expertise in micro-pattern gas detectors and INFN expertise in resistive-plate chamber technology. The result is a novel type of gaseous radiation detector whose combined characteristics of high spatial resolution, high time-resolution (less than 100 ps) and high rate capability (1 MHz per cm^2) exceed those of conventional detectors. In addition to meeting the demanding requirements of high-energy physics experiments, such as CMS, this type of detector is particularly suitable for applications in medicine such as small animal PET scanners (time-of-flight PET scanning), radiation monitoring and molecular analysis (small angle x-ray crystallography). The technology is the first of its kind in the field of gaseous radiation detectors and may open up new applications of such detectors in society. It was therefore patented in 2014 in order to secure protection and to facilitate licensing of the technology, in close cooperation between CERN and INFN.

Technical contact: Archana Sharma, Physics Department



Members of the THRAC team demonstrate the device

Trademarks

Kryolize

Kryolize is a newly-developed piece of software, used for sizing the minimum discharge-area of a pressure-relief safety device in order to protect cryogenic equipment from accidental overpressure. The software is the reference guideline, used at CERN, to ensure that the pressure of the vessel will not exceed the maximum allowable pressure and therefore respect safety rules for pressure equipment. Developed by the HSE Unit, the software made at CERN is based on International (ISO), European (EN) and American (API) standards and is adapted from models, tailored to cryogenic fluids.



The Kryolize logo, developed with CERN's Graphic Design team

Trademarks at CERN

Kryolize has been registered as a Community Trademark at the EU's Office for Harmonization of the Internal Market (OHIM). CERN now owns several trademarks worldwide, including Indico, Zenodo and Helix Nebula. Why do we hold trademarks when we are not a commercial organization?

We want our most visible projects to have a distinctive and recognizable name that we can use freely and peacefully. As even non-profit operations can fall within the scope of using a name 'in trade' (one of the criteria for determining trademark infringement), trademark registration gives the Organization a safeguard against claims by third parties to the names of our projects. It is not uncommon for names of visible and recognized projects to be abused by less well-intentioned individuals, thereby diluting CERN's impact on society through these projects. A trademark gives us the legal means to stop such abuses, a possibility that is not to be used lightly.

Trademarks are also an important instrument of knowledge transfer through CERN spin-offs and start-ups, which can benefit from the recognition built up through the trademark by CERN. While it is not financially justifiable to register names of CERN initiatives and projects systematically, the KT Group offers the possibility to perform clearance searches to assess the risk of conflict with existing trademarks.

The software has already been licensed to three external institutions and CERN is in the process of signing a fourth agreement at the time of writing. Kryolize finds a range of potential applications in a number of different domains that use cryogenics, including cryoplant manufacturers and design offices, valve manufacturers, cryogenic systems at research laboratories such as cryostats and cryomodules, and cryogenic systems at medical applications such as low-temperature preservation, MRI and cryosurgery. In order to develop Kryolize into a trusted tool, the HSE Unit worked with KT and the CERN Design Office to create the Kryolize name and logo, which have been trademarked.

Technical contact: Andre Henriques, HSE Unit

Selection of TT cases

Cubesat study

A Cubesat is a miniaturized satellite that typically uses commercial off-the-shelf components for its electronics. Mini-satellites are increasingly attractive for small-budget space science missions,

especially for universities, although commercial applications are also becoming increasingly frequent. The Cubesat project is a student-project collaboration between CERN, the University of Montpellier, the Van-Allan foundation and ESA. It proposes a test set-up of a radiation monitoring unit coupled with a latch-up test station. The former is based on a CERN radiation monitor, RadMon, while the latter will focus on latch-up measurements of memory components used for accelerator applications but also for ground and space applications. Both the test set-up and an entire Cubesat device will be verified in a new flexible CERN radiation test facility called CHARM, which can reproduce the space-mission radiation environment. This new facility has much potential since it will offer a faster and cheaper way to verify a full electronic design in comparison to the current scheme, where tests of individual electronic components are carried out in irradiation facilities that are not easily accessible and at significant cost. CHARM is therefore generating much interest from universities and it is expected that industry will also be interested in the approach.

Technical contacts: Markus Brugger and Roberto Losito, Engineering Department

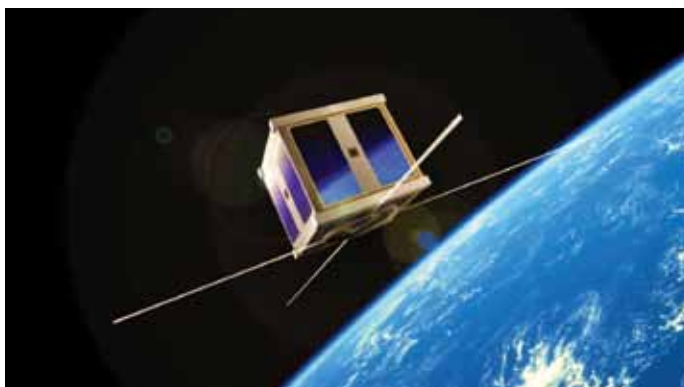

Computer image of AAU Cubesat in orbit around the Earth

Latch-up monitoring system

Latch-up is a radiation-induced failure effect in electronics components that, put simply, shorts the power-supply rail to the ground of the circuit, triggering a drastic increase of current consumption that can permanently damage the component. The latch-up monitoring system was designed to evaluate the sensitivity of electronics components to such phenomena, allowing the detection of fast, low or user-defined variations of their current consumption. The system is modular (PXI based), allowing testing of a large set of components at the same time. The main application of this technology is the characterization of electronics exposed to ionizing radiation. The tested electronics can be discrete components or a full design. This system could be used by the aerospace and the accelerator communities. Currently, two external companies are interested in exploiting this technology in Europe and the USA. The KT Group will provide support on the preparation of the licence agreements.
Technical contact: Alessandro Masi, Engineering Department

ActiWiz

ActiWiz is a software package allowing for fast relative comparisons of the radiological hazard presented by various materials used in high-energy particle accelerators, thus allowing the user to experiment with different compositions in order to minimize component activation. Based on a large amount of generic FLUKA Monte Carlo simulations, ActiWiz also applies a specifically developed risk-assessment model to provide support to decision makers for choosing materials with low(er) activation risks. ActiWiz was conceived for material optimization at CERN's accelerator complex from a radiological point of view, but it can be applied to similar accelerator environments. Recent developments have also included features that make the software appealing for operational radiation-protection tasks that are not limited to CERN. Researchers from collaborating labs were quick to recognize the value that ActiWiz could bring to their work by removing the complex and time-consuming task of determining the materials with low activation potential. Over recent years, academic licences for ActiWiz have been given to KEK in Japan, Jefferson Lab and Michigan State University in the USA, PSI in Switzerland and GSI in Germany. However, it is not only the academic community that takes notice of ActiWiz's potential. Recently, hadron-therapy centres have also expressed

an interest in the software, with one centre already having acquired a licence.

Technical contacts: Helmut Vinke and Chris Theis, HSE Unit

TDCpix

The NA62 experiment is under development at the CERN Super Proton Synchrotron and aims to measure ultra-rare kaon decays. The experiment uses the Giga-tracker (GTK) detector – a hybrid silicon-pixel detector that combines on-beam tracking of individual particles with very good timing resolution. The Gigatracker readout chip, TDCpix, has been designed, manufactured and its performance evaluated. It features 1800 squared pixels of $300 \times 300 \mu\text{m}^2$ arranged in a matrix of 45 rows \times 40 columns. Bump-bonded to a silicon pixel sensor, it will perform time stamping of particle hits with a timing accuracy better than 200 ps and a detection efficiency of 99%. In addition to high-energy physics applications, other potential fields of application for this technology include time-of-flight positron emission tomography (TOF-PET), fast neutron imaging, life sciences applications such as fluorescence-lifetime imaging (FLIM) or fluorescence correlation spectroscopy (FCS), scientific and engineering instrumentation and time-of-flight mass spectrometry.

Technical contact: Alex Kluge, Physics Department

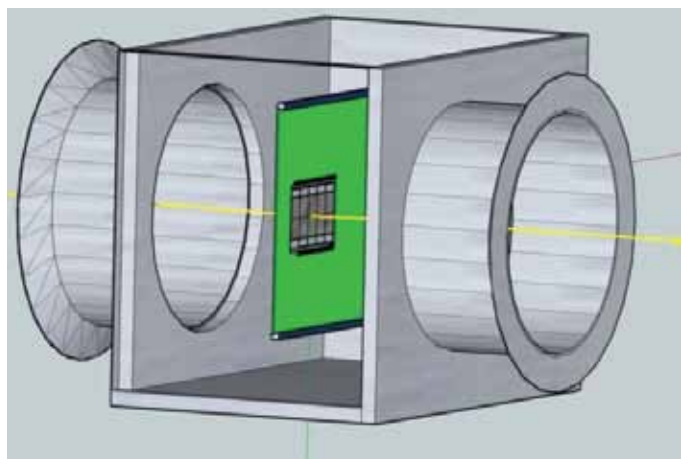

Schematic of the GTK station in the NA62 experiment

fwWebViewPlus and WinCC OA

Controls engineers are probably familiar with the WinCC OA object-oriented SCADA (supervisory control and data acquisition) system, provided by a leading industrial company, which is a major player in the industrial controls field. This system is used extensively at CERN including in the CERN Control Centre to control the accelerator complex. It was the visualization needs of CERN users and operators that drove the development of 'fwWebViewPlus' – a piece of software developed by the EN Department that allows reuse of 'any' generic visualization widget used on web pages (e.g. graphing libraries, tables, etc.) and seamless integration into WinCC OA. This enhances the ergonomics and appeal of operators' consoles, making their job easier and increasing their efficiency.

The software designers wanted to leverage the plethora of reusable graphical components, such as Google Chart Tools and JQuery Sparklines, implemented in JavaScript that run inside a web browser. Re-using widely available widget libraries, to push the development efforts to a higher abstraction layer based on a scripting language, results in a significant reduction in maintenance of the code in multi-platform environments compared with those currently used in C++ visualization plugins. This component gives the possibility to any user of WinCC OA employing numerous visualization widgets to integrate these seamlessly into their control systems. The WinCC OA providers were quick to see the potential use of the CERN-developed 'fwWebViewPlus' component as a 'bridge' to port the WinCC OA Human-Machine Interfaces to web-based technologies. They thus showed great interest in making the code available as an integral part of their software environment. This is a great example of direct technology transfer to industry and a clear win-win situation since CERN will benefit from the further developments and maintenance of the code, while at the same time its use will be spread to a wider user-community by the WinCC OA providers.

Technical contacts: Manuel Gonzalez Berges and Piotr Golonka, Engineering Department

UAV: Unmanned aerial vehicle

Robotic indoor autonomous navigation is a crucial requirement for many challenging applications, such as the inspection of unstructured and harsh environments. In the absence of global positioning information – for example 'GPS-denied' locations – the robot state (positioning and mapping) is essential to achieve safe and reliable autonomous navigation. At the current time, a full autonomous robot navigation system is not available. CERN, in collaboration with an external company, will develop 3D time-of-flight sensors suitable to be used as positioning sensors to define the robot state in autonomous navigation frameworks. The potential applications are wide-ranging and numerous and include search and rescue, inspection (buildings, mines, abyss, water/oil/gas water and pipes), production environments, green houses, package delivery, hospitals and logistics.

Technical contact: Alessandro Masi, Engineering Department

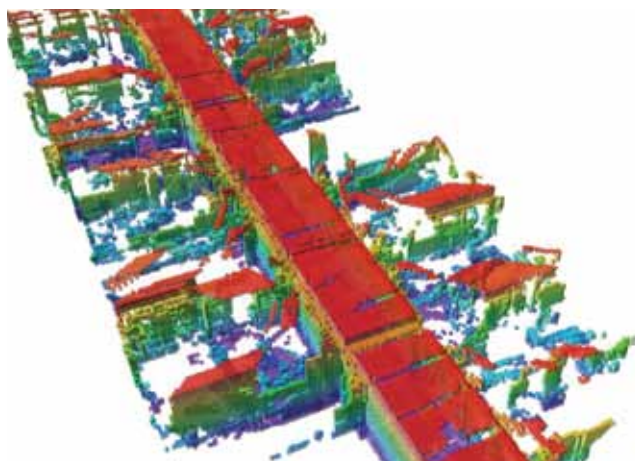

Example of an environmental map reconstruction for autonomous indoor navigation

Scalable Readout System

The RD51 collaboration brings together more than 80 institutions worldwide with the aim of supporting the development of micro-pattern gas detectors (MPGD) and associated electronics systems for the readout of such detectors. A dedicated working group formed within the collaboration has been mandated to establish a portable, multi-channel readout system for multi-pattern gas detectors and to develop a discharge-protection strategy to protect the electronics when used for gas detectors such as Micro-Megas or GEMs. In 2009, the Scalable Readout System (SRS) was proposed as a scalable, crate-based electronics architecture consisting of electronic front-end concentrator cards (FECs) with digital or analogue adapter cards with chip link interfaces. The links transmit data trigger clock and controls (DTCC) and optionally, power to the front-end. This concept allows the selection of the appropriate front-end technology for a given detector type. A single FEC/adapter Combo can be used as complete readout system for a modest number of detector channels. Large systems are an aggregation of many Combos via a scalable readout unit (SRU). Multi-channel SRS hybrids are built around different types of front-end ASICs and include spark protection and DTCC interface. The SRS hardware is bundled with SRS firmware (FPGA), test system software (LabVIEW) and standard online software (DATE). In 2010 the first SRS prototypes were produced at CERN as in-house prototypes and successfully used for cosmic tomography with GEM detectors and for tests of ATLAS Micro-Mega stations at the CERN SPS. Following this encouraging experience, commercially produced SRS systems were deployed for both MPGD and photon-detector (calorimeter, time-projection chamber) communities. It is currently available in two flavours: the classic version of the SRS with very low channel-cost, or the version with small portable size (Mini-crates) for desktop applications in detector R&D environments. SRS ATCA is integrated into the industrial ATCA standard, providing significantly higher channel-density as required for the experiments in the LHC.

Technical contact: Hans Müller, Physics Department



View of a full-size 14-slot SRS-ATCA crate

ASD-AR

The main purpose of EDUSAFE, a Marie-Curie ITN project, is to use Augmented Reality (AR) and Virtual Reality (VR) technology in reducing the exposure of personnel during planned and emergency maintenance in extreme environments. AR software developed as part of a personnel safety system was extended and adapted to help children with autistic spectrum disorder (ASD) in improving their learning skills.

CERN researchers worked in collaboration with the University of Modena and Reggio Emilia to develop AR training software that allows parents and teachers to empower learning abilities of ASD children by using visual aids. Testing and evaluation of the software will be done by the European Institute for the Study of Human Behaviour (IESCUM), which is a non-profit organization located in Parma, Italy. Following initial field-testing and feedback, the CERN researchers aim to improve the software to increase its potential and widen its use among health professionals who deal with ASD children.

Technical contacts: Olga Beltramello and Lakshmi Prabha Nattamai Sekar, Physics Department

Arc detector for high-power RF systems



Photograph of the Arc detector receiver supplied by the Slovakian company

This technology was featured in the 2013 report and at that time the technology was fully developed and characterized in the LHC environment, with technical experts working on transferring it together with the required know-how and expertise to an external company in Slovakia. This company was able to deliver a production series of the required number of detector units to CERN's LINAC4 project. During this technology-transfer process, the Slovakian company made a significant contribution in transforming the CERN experimental device into a state-of-the-art object suitable for industrial production. Given the potential market-niche in the field of research, the company has recently been granted a commercial licence to sell products incorporating the technology to other research facilities. CERN is currently helping evaluation of the technology by the European

Synchrotron Radiation Facility and is in the process of signing non-disclosure agreements with the Brookhaven National Laboratory and the European Spallation Source to cover their further evaluation of this technology. Furthermore, another potential field of application has been identified in protection systems for industrial microwave ovens and is under evaluation by the KT Group.

Technical contacts: Daniel Valuch and Olivier Brunner, Beams Department

NINO

This application-specific integrated circuit (ASIC) is an eight-channel, ultra-fast differential amplifier discriminator that was used as part of the front-end electronics for the time-of-flight detector within the ALICE experiment, to readout the signal coming from the multigap resistive plate chambers. This ASIC was developed in the early 2000s in the context of the LAA project. The implementation of the LAA project at CERN started in 1986 with the aim of proving the feasibility of new detector technologies that could be used in future multi-TeV hadron colliders. In 2014 this technology has proved very popular for R&D applications. Three licences have been signed in the fields of photon-tagging spectrometry, readout of position-sensitive scintillators for fast neutron spectrometry and readout of silicon photomultipliers for time-resolved fluorescence spectroscopy, with research centres located in UK, Slovakia and China, respectively. Another four licences will be signed imminently in the fields of light-detection and ranging (LIDAR), cosmic-muon detection, proton spectrometry and time-of-flight positron emission tomography, with research facilities in Spain, Romania, Portugal and the USA. New incoming requests will apply this technology for the readout of micro-channel plate detectors in biomedical and nuclear-imaging applications.

Technical contact: Crispin Williams, INFN and CERN Physics Department



A printed-circuit carrier board for the NINO chip

Electropolishing

The CERN method of electropolishing of titanium and aluminium compounds achieves very smooth surfaces. At the current time, several discussions are ongoing with companies in a variety of industrial fields. Non-disclosure agreements have been signed and a range of specimens from different companies have been polished at CERN, sometimes in the presence of company representatives. The results are analysed in-house by the companies. A major commercial aerospace organization has upgraded this topic to a PhD project, and one of the first commercial organizations in 3D printing has shown strong interest in an agreement on additive manufacturing research.

Technical contact: Leonel Ferreira, Technology Department



Close up of two tubes before (left) and after electropolishing. Short-wavelength roughness is strongly reduced, while long-wavelength roughness largely remains

BlogForever

BlogForever originated as an EC FP7 project bringing together 12 partners from 6 European countries, coordinated by the Aristotle University of Thessaloniki in Greece, with CERN leading the technology work package. The project developed a new system to harvest, preserve, analyse and disseminate blog content. Using intelligent harvesting, the system retrieves and parses blog content, from blog post text through embedded images to user comments. The output of this operation is structured data, expressed in the same XML data model regardless of blog source or platform, and enriched with semantic information extracted by the crawler. This allows the organization of information such as authors, dates, tags, comments, topics and links within a hierarchical structure and their storage into a repository, based on CERN's Invenio technology, for subsequent exploitation and analysis.

In the domain of high-energy physics, the blog-archiving technology developed within the BlogForever FP7 project opens a possibility to set up a particle-physics blog archive at CERN, which could systematically harvest content from the particle-physics blogosphere, facilitating the information exchange and exploitation through linking to scientific publications or tracking

of ideas. A team from Thessaloniki further investigated the business potential of the system after the EC project terminated at the end of 2013 with the idea to provide a commercial service based on it. After having done a thorough market research, they put together a business plan to create a CERN spin-out company to provide blog preservation and analysis services starting with memory institutions. The idea is to develop a SaaS (Software as a service) platform offering different types of subscriptions to potential customers. The team, which is comprised of people with confirmed business experience and with links to the Aristotle University of Thessaloniki, is already active in the space of web content collection, management and dissemination via other business ventures. Preparations are under way for the company to be incorporated in Greece in early 2015, making them a perfect candidate for applying to the BIC of CERN Technologies of Technopolis in Thessaloniki, Greece, which was established in December 2014 (see p. 39).

Technical contacts: Nikos Kasioumis and Tibor Simko, IT Department

Medipix

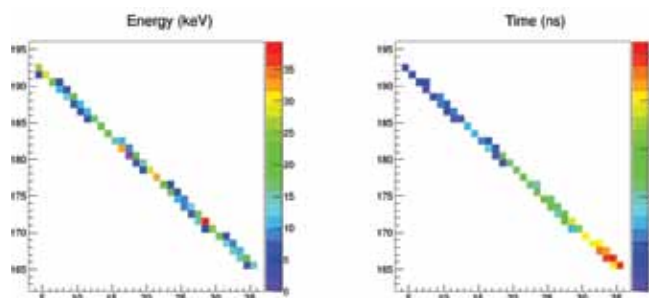

Track of a cosmic muon recorded with a Timepix3 chip. The x- and y-axes represent the pixel coordinates. The colours on the left image represent the quantity of charge measured by each pixel. The colours on the right image represent the arrival time (normalized to the time of the first hit pixel). From these one can determine the angle of the track

This technology has been and continues to be an active and successful example of technology transfer. Two Timepix chips were incorporated into a battery-operated system that flew on the NASA Orion rocket in December 2014. This development, driven by a Medipix2 Collaboration member, the University of Houston, provides a very compact and low-power solution to measure the radiation field to which astronauts are exposed. The CERN@school project, which uses Timepix chips in the classroom, has continued to develop in the UK. A special one-day workshop for high-school students was held at the University of Surrey in conjunction with the Position Sensitive Detectors Conference. In a joint session with the conference attendees, students from various schools presented their projects using the Timepix chips in several applications. These presentations, which were of extremely high quality, demonstrated that such research activities can be a major motivator in encouraging interest in STEM subjects. The Medipix3 Collaboration also saw the launch of the first commercial products in the x-ray diffraction field. A further spin-off company was created from

a collaboration member and another licence signed with an already-existing spin-off of another collaboration member. The Timepix3 chip was combined with silicon sensors and used in test beams by both the LHCb and the AEGIS experiments at CERN. The performance in each case was excellent. As the chip time-stamps hits to 1.6 ns it is possible to reconstruct a track within a silicon sensor for the first time – a kind of semiconductor TDC.

Technical contact: Michael Campbell, Physics Department

High-performance time-to-digital converter

A time-to-digital converter (TDC) is a device used to measure time intervals with high precision. It usually permits two types of time measurements. Start-stop measurements concern the time interval between two events. This mode is used to measure relatively short time intervals with high precision. In particle physics, it allows determination of the energy deposited by a particle in a detector. Time-tagging measures the time of occurrence of events with respect to a given time reference. In particle physics, the time reference is a clock and the events are the hits of particles in the detector whose front-end electronics contains the TDC. In the context of the development of time-of-flight detectors for the LHC experiments, the CERN Microelectronics Section developed the high-performance TDC (HPTDC) chip some years ago. However, the chip remains popular due to its favourable performance and flexibility in terms of number of channels and timing resolution. There have been previous commercialization activities of the HPTDC by several companies in applications such as time-of-flight mass spectrometry, light-detection and ranging, electronic testing and life sciences. An agreement has been signed between CERN and an external company, permitting CERN to supply HPTDC chips to this company and granting it the right to incorporate it into scientific and engineering instrumentation products that will be subsequently commercialized. The CERN PH-ESE Group is currently working in the development of the next generation TDC in 65 nm CMOS technology, doubling the number of channels (64) with eight times better time resolution (3 ps binning) for a large number of applications. The full chip is expected to be ready in mid 2016.

Technical contact: Jorgen Christiansen, Physics Department

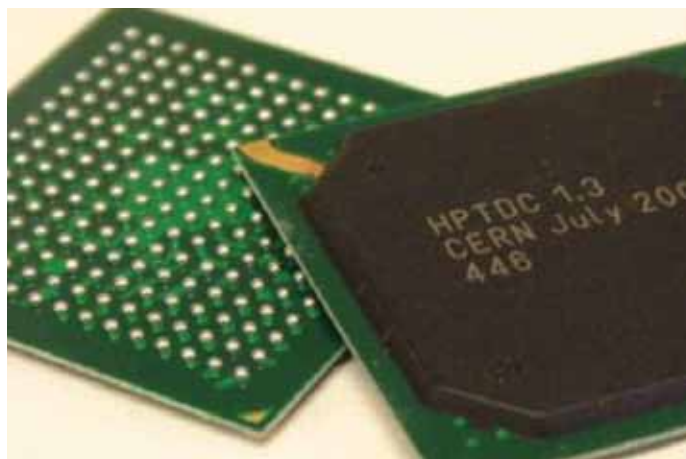

Photograph of the HPTDC chip

BE and EN Department Innovation Days

BE-KT Innovation Day

The year 2014 saw the second edition of what will become an annual event, the BE-KT Innovation day. The core work in the Beams (BE) Department often requires the development of innovative solutions to technical and engineering problems, many of which could have wider applications. The BE-KT day brings members of the KT Group together with engineers and physicists of the BE Department to exchange ideas, share experiences and foster an environment to encourage and promote KT as part of the core activities of CERN.

“The 2014 BE-KT day was once again a great success. The format is proving very useful and other departments are now planning, or running, similar events.” Paul Collier, BE Department Head.

EN-KT Innovation Day

The year also saw the first innovation day with the Engineering Department (EN), following a similar format to that successfully applied in BE. The day-long programme consisted of 16 presentations on current and new projects ranging from additive manufacturing techniques, through software and 3D interferometry to autonomous navigable robots, with many more in between. The technologies presented find potential applications in a range of fields including aerospace, metrology and surveying, medicine and safety.

“All [of the projects] are being studied to identify the best way to propose them for transfer to industry, with three having made a KT Fund request.” Roberto Saban, EN Department Head.

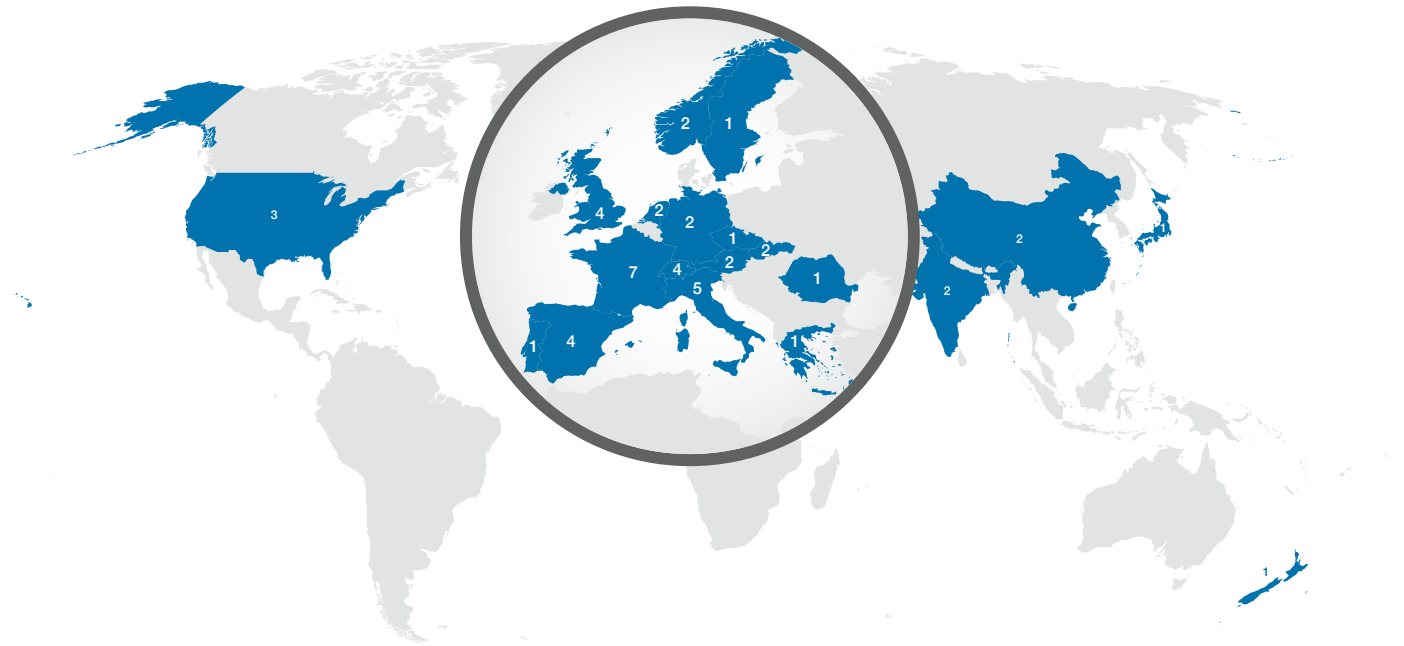

Agreements signed

The table, right, shows the knowledge-transfer agreements formalized in 2014. The map above shows their distribution across various Member States of CERN and beyond.

Technology	Type of agreement	Type of partner	Country
Medipix3 chip	Amendment to licence agreement	Commercial	NZ
Medipix3 chip	2 licence agreements	Commercial	UK, DE
Hadron therapy	Amendment to collaboration agreement	Academic	IT
Hadron therapy	Addendum to partnership agreement	Commercial	CH
Superconducting mini-cyclotron	Amendment to contract research agreement	Academic	ES
Photonic crystals	Addendum to collaboration agreement	Commercial	FR
Photonic crystals	Collaboration agreement	Academic	FR
MicroMegas detectors	Licence agreement	Academic	FR
MicroMegas detectors	IP joint ownership agreement	Academic	FR
New etching method for GEM detector foil manufacturing	Licence agreement	Commercial	IN
GEM detector foils	Licence agreement	Commercial	IN
CDS Invenio digital library software	Spin-off licence agreement	Commercial	NO
Cryogenic thermometer measurement chain	Licence agreement	Academic	FR
CLIC high-gradient accelerating structures	Collaboration agreement	Commercial	NL
DC current transformer calibrator (DCCT)	Service agreement	Academic	US
DC current transformer calibrator (DCCT)	Service agreement	Commercial	CH
Software for DC current transformer calibrator (DCCT)	Licence agreement	Commercial	CH
Software for DC current transformer calibrator (DCCT)	Licence agreement	Academic	US
FLUKA particle physics Monte Carlo simulation software	Licence agreement	Commercial	UK
High-performance time to digital converter ASIC	Licence agreement	Commercial	IT
Mounting mechanism for drift-tube linac	Licence agreement	Academic	ES
CERN-DxRuCT-128AC ASIC for photon counting	Licence agreement	Commercial	DE
Roxie software for simulation and optimization of accelerator magnets	3 Licence agreements	Academic	ES, FR, CN
Portable radiation survey meter operable in high magnetic fields (B-RAD)	IP Joint ownership agreement	Academic	IT
VoltCal & ResCal calibration software	Collaboration agreement	Academic	CH
ActiWiz radiological hazard assessment software	2 Licence agreements	Academic	US, JP
ActiWiz radiological hazard assessment software	Licence agreement	Commercial	AT
IP core for TCP protocol	Licence agreement	Academic	CZ
Additive manufacturing	Spin-off licence agreement	Commercial	UK
Kryolize software for sizing safety valves	3 Licence agreements	Academic	IT, SE, FR
NINO-IRPICS chip	6 Licence agreements	Academic	PT, CN, ES, UK, SK, RO
Autism spectrum disorder – augmented reality software	Licence agreement	Academic	IT
	BIC agreement	Academic	NL
	BIC agreement	Commercial	GR
	BIC agreement	Commercial	AT
	BIC agreement	Academic	NO
Arc detector sensor and receiver	Licence agreement	Commercial	SK

KT Fund

The KT Fund supports selected knowledge-transfer initiatives, in part by re-investing a portion of the revenues generated by CERN's IP dissemination activities. The KT Fund selection-committee is composed of all departmental heads and members of the KT Group. Proposals are submitted for evaluation and selection based upon their suitability for seed funding and KT potential.

The fund was set up in 2011 and over the past four years has provided proof-of-concept seed funding to 25 projects, worth 2 million CHF. Summaries of the new projects funded in 2014 can be found below, together with progress reports for selected on-going projects and details of selected completed projects.

2014 projects

High-pressure laminates for electrostatic dissipative applications

High-pressure laminates (HPL) are considered one of the most durable decorative surface materials, with applications in countertops, furniture, high-traffic settings such as hospitality, office furniture, healthcare, retail casework, commercial interiors and educational facilities. The technical goal of this project is the definition and validation of an industrial procedure for suitable HPL for electrostatic dissipative and dust-free furniture applications. The new industrial procedure should secure a <1% rejection factor. Two industrial partners have already been identified and agreements are being negotiated.

Technical contacts: Salvatore Buontempo and Paolo Vitulo (INFN), Martin Gastal (Physics Department)

Generic controller for power converters for dissemination to partner laboratories and commercialization

In particle accelerators hundreds to thousands of power converters are necessary to feed magnets and RF systems, which must be controlled and monitored in an efficient and coordinated way. For this purpose and to reduce costs, a standardized controller able to comply with the functional requirements of all of the power converters is a must. CERN has developed its own power-converters controller – the function generator controller (FGC) – which is dependent on the CERN control environment. The controller must be placed into a communication environment which includes both electronics hardware and software.

The synchrotron light-source community has developed two common control environments, namely TANGO and EPICS, which are not used at CERN. The aim of this project is to modify the FGC software to be compatible with the TANGO and/or EPICS environments. With a generic FGC, all power converters developed at CERN could be much easily transferred to partner laboratories and to industry. The potential applications apart from physics are medical and biological. Currently, the requirements are being defined and discussions are ongoing with the European Synchrotron Radiation Facility, which provides expertise in the TANGO environment, to decide about which is the best way to proceed among the several possible options.

Technical contact: Jean-Paul Burnet, Quentin King and Marc Magrans de Abril (Technology Department)

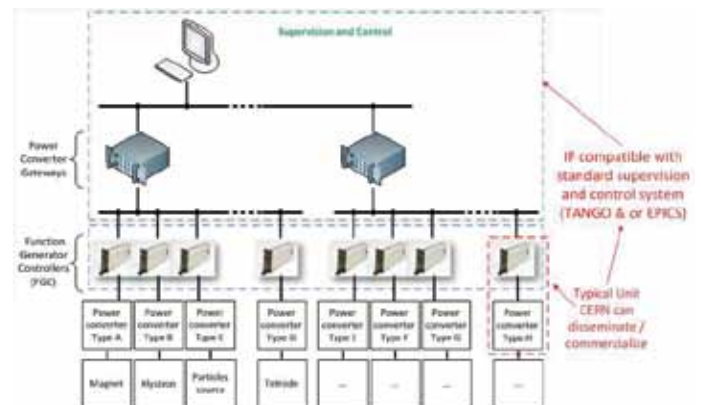

Power converter infrastructure in CERN accelerators

Development of the FLUKA code for hadron therapy

In April 2014, a dedicated project was approved and funded by the KT Fund in order to develop the FLUKA code for hadron therapy. More details on this project can be found in chapter 1 of the report (p.19).

Technical contacts: Alfredo Ferrari and Thierry Stora (Engineering Department)

Compact orbital pipe-cutting equipment

The maintenance and upgrade work during the Long Shutdown 1 (LS1) of the LHC has brought to light a practical challenge for CERN technicians: cutting a wide range of pipes of stainless steel in conditions of limited accessibility and absence of space around the pipes. Traditional pipe cutting tools are quite large and bulky and are adapted to only a small range of pipe diameters. Facing that challenge, Didier Lombard, Group Technician in EN/MME came up with a creative solution and built a prototype in his spare time: a chain tightened around the pipe, a motorized mill/saw cutting tool and a manual displacement of the tool along the chain around the pipe. This results in a more compact solution,

with the additional advantage of more universal use, adapting itself to a wide range of diameters. The KT Fund now supports the industrialization of this concept by funding the further engineering and developments of the machine. With a motorized drive around the pipe, a compact design and improvements in the usability of the machine, this compact cutting machine becomes interesting for companies with similar requirements, such as heating, ventilation and air-conditioning (HVAC) installations, or companies seeking a universal alternative to having a wide range of cutting equipment of different diameters.
Technical contact: Didier Lombard (Engineering Department)

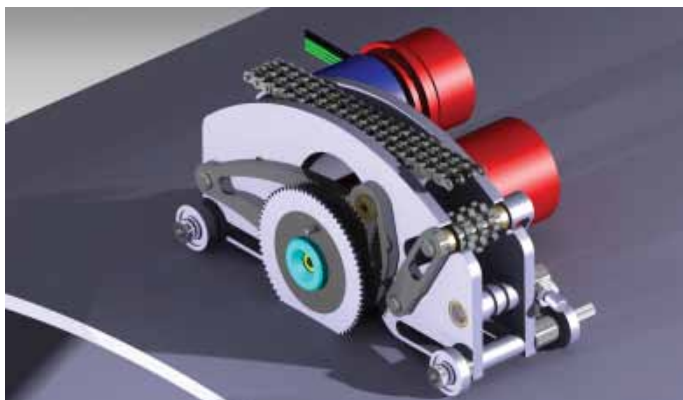

3D rendering of the compact orbital pipe-cutting device

Compact, light, fast trimmable magnets for medical accelerators

The aim of this project is to produce a prototype magnet in order to demonstrate the feasibility of a new generation of compact, and therefore less expensive, medical gantries for cancer particle therapy. The study on this magnet was tailored to particle-therapy machines designed by the TERA Foundation for cancer treatment. The principal innovation is the use of an iron cobalt (FeCo) alloy to build a laminated yoke. FeCo is a soft magnetic alloy showing a linear magnetic behaviour up to a saturation field of 2.35 T, about 0.7 T higher than for a standard FeSi alloy. This allows for the construction of a magnet 30% lighter than a conventional one, which in addition provides excellent dynamic characteristics thanks to the high electrical resistivity of this alloy.

Technical contacts: Davide Tommasini and Roberto Lopez (Technology Department)

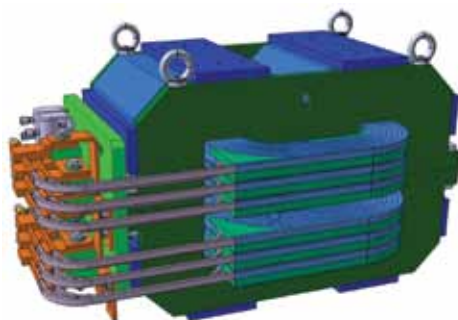

Schematic design of the FeCo prototype magnet

High-power testing of a medical high-gradient accelerating structure for proton therapy

The aim of this project is high-gradient conditioning and operation of the prototype 3 GHz medical linac accelerating structure, currently under fabrication. The project follows on from a previous successfully-delivered KT Fund project in 2012, whose objective was to design and fabricate the two high-power prototypes – one optimized for 76 MeV protons, the other for 213 MeV (corresponding to the lowest and highest energy for the main part of a proton-therapy linac). The field of application of this technology is generally medical linacs for proton and carbon-ion cancer therapy. The structures proposed are specifically optimized for use in gantry-mounted linacs for compact, single-room proton-therapy facilities such as TULIP, proposed by the TERA Foundation. Such a development would both significantly increase the flexibility and reduce the cost of particle therapy.

Technical contact: Walter Wuensch (Beams Department)

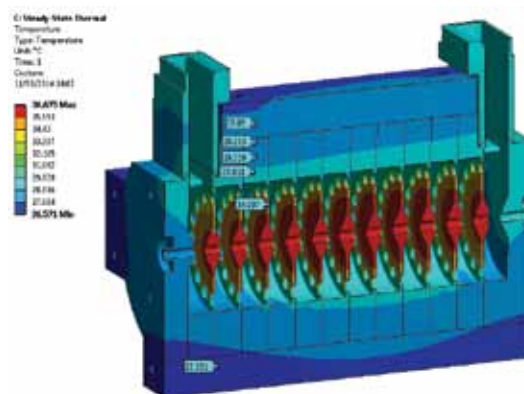

Mechanical design of the prototype accelerating structure for proton-therapy linacs used for thermal and electromagnetic simulations

On-going projects

Development of a SiPM-based detector module to be used in commercial versions of ClearPEM machines as well as for other PET applications

This work is being performed in collaboration with three external institutes from Belgium, Portugal and Italy, all of them members of the Crystal Clear Collaboration. During 2014, simulation work was performed to evaluate the light-sharing performance. A test set-up was built to test different matrices and light-sharing configurations. First modules of 64 crystals with dimensions 1.5 x 1.5 x 15 mm³ coupled to a 4 x 4 array of multi-pixel photon counters with 3 x 3 mm² sensitive area were produced and characterized and the position identification of the 64 crystals was achieved. The next step will be to optimize the reconstruction method of the crystal position and investigate methods to extract the information about the depth of interaction by reading out on one end of the crystals.

Technical contact: Etienne Auffray Hillemans (Physics Department)

Electronic design automation software suite

KiCad is an open source software tool for the design of schematics for electronic circuits and their conversion into printed circuit boards (PCBs). The KiCad project aims to provide developers around the world with a universal, professional tool to freely design PCBs and exchange schematics without the restrictions imposed by proprietary software, and thus encourage and facilitate the exchange of designs and knowledge. Furthermore, it will incite more designers to share circuit designs directly or through open repositories, such as the Open Hardware repository, thus generating opportunities for companies and individuals around these designs. Apart from directly benefiting the electronics design community, KiCad is of great educational value, providing academics and students with a powerful tool to teach and learn real-life electronics through the design of actual circuits in the context of their studies. In addition, because KiCad is free software, students wanting to pursue developments outside of regular lecture times will be free to do so. The KiCad project was started by Jean-Pierre Charras, a researcher in the field of electrical engineering at GIPSA-LAB in France. CERN plays a major role in the KiCad effort and has already contributed extensively in the tool-development and direction.

Technical contact: Javier Serrano (Beams Department)



Screenshot from the KiCad user-interface showing an example of a design created with the tool

Apparatus to study liquid samples under high vacuum

The aim of this project is to build and test a system for the study of biologically important metals (Cu, Mg, Zn). The system will overcome the problems of vacuum difference to make such work possible for the very first time. The project is highly novel, allowing for the first time direct observation and study of metal ions in biological systems. Testing of the differential vacuum system has validated the technique and IP protection of system components is currently under assessment. The project aims to revolutionize the study of metal ions in aqueous solution for a wide range of potential applications. Project progress to date is good, with the system pumps tested and ready for configuration, vacuum and beam transmission begun, simulations of beam

transport and pump power complete, and patentability of system components at an advanced stage.

The fields of application of this technology are wide-ranging and include other scientific domains such as:

- Chemistry and biology: study of liquid samples of biological material to derive molecular and atomic structure information
- Pharmacology and medicine: pharmaceutical behaviour & function in aqueous solution, currently only observed by indirect methods
- Material science: study of liquids and gels to understand aging, swelling, change of materials exposed to humidity
- There are also potential industrial applications in cosmetics, drug discovery, and food and drink ingredients markets.

Technical contact: Monika Stachura (Physics Department)

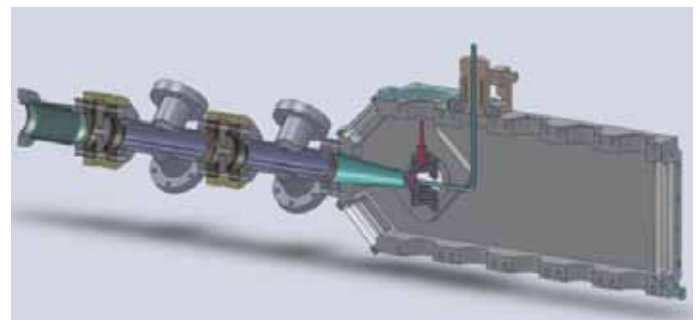

Schematic of the differential pumping system and liquid feedthrough chamber for biological sample suspension and analysis

Additive manufacturing techniques using copper and niobium

Additive manufacturing is a rapidly growing field that offers benefits to many application domains, including parts for the LHC. The aim of this project is to advance with identified academic and industrial partners on the development of additive manufacturing with copper and niobium and maximize exploitation. Glow-discharge mass-spectrometry and instrumental gas analysis are performed at CERN and results compared to determine changes in composition induced by the fabrication process. The academic collaboration to manufacture and analyse specifically designed parts is now under way. After an agreement could not be reached with the originally foreseen company, an agreement with a new partner is close to finalization.

Technical contacts: Ofelia Capatina, Said Atieh and Thomas Sahner (Engineering Department)



A part designed for the LHC, produced by additive manufacturing of niobium (compound)

Dual-modality approach to motion-corrected tomography for medical applications

The aim of this project is to develop a motion-corrected tomography system, combining electrical impedance tomography and x-ray CT imaging, for radiotherapy. One of the reasons for cancer treatment failure – particularly in lung and liver cases – is that internal organs move when the patient breathes, literally making tumours a moving target. At the current time, around 30% of conventional radiotherapy treatments fail and the project hopes to improve this statistic by enhancing the efficacy of radiotherapy as a treatment for cancer. The project is a collaboration with the Engineering Tomography Laboratory at a UK-based university and KT funding helps to support two full-time PhD students. Progress to date has been good, with a model of breathing motion having been generated from data simulations, and validation and calibration using data from phantom experiments on-going.

Technical contacts: Steven Hancock (Beams Department) and Manjit Dosanjh (Finance, Procurement and Knowledge Transfer Department)

Humidity fibre-optic sensors

From the testing on laboratory prototypes it was found that titanium dioxide shows better performance in terms of sensitivity to humidity in comparison with tin dioxide. Preliminary irradiation campaigns on TiO₂-coated long-period grating (LPG) samples at 10 kGy γ -ionizing radiation dose have been performed. A long-term irradiation campaign is in preparation pending the completion of a pre-series of 24 new samples, currently in fabrication. Half of the samples within this new set will be coated but not the other half so that the contribution to the sensor performance degradation due to radiation of the grating and of the coating can be characterized separately. The characterization of the packaging in aluminium for the LPG-based relative humidity fibre-optic sensor is finished. The prototype sensors until now have been produced via a controlled oxide coating of the LPG on the fibre with the sol-gel deposition technique. Another oxide-coating technique based on vapour deposition under vacuum is currently being tested by the Thin Film Team of PH-DT-DD. This alternative technique is expected to be more repeatable and to provide in general a better quality oxide-coating.

After a meeting between CERN and the two external partners involved in these developments, a draft agreement for exploitation of jointly owned intellectual property is being negotiated. The technical specifications of these humidity sensors were prepared and 30 companies in the field of fibre-optic sensors were approached to evaluate the commercial potential of this technology. Two thirds of these companies were not interested but there is potential within the remaining third. As a starting point, there will be follow-up on the interest shown by one of the companies to evaluate the possibility to adapt the technology to suit industry.

Technical contact: Paolo Petagna (Physics Department)

Materials for thermal management

The research on thermal management materials for the LHC collimators takes place in the framework of the EuCARD-2

WP11 project. In the context of its wider potential impact with applications in e.g. electronics, aerospace, and the automotive industry, the development of an industrially applicable material is supported by the KT Fund. The aim is to exploit fully the beneficial properties of investigated materials in these industrial fields. The most promising materials have now been identified as copper-diamond (Cu-CD) and molybdenum-graphite (Mo-Gr), the latter being particularly appealing as it is easy to machine, versatile and can be coated with a Mo layer, dramatically increasing electrical conductivity. A large range of companies operating in the different domains have been contacted, and constructive exchanges are ongoing to reach optimal parameters. A test set-up was presented at the Hannover Messe and a group of entrepreneurial students was supervised to perform a survey. Recently, a paper that focuses on the applications has been accepted for presentation at a major annual thermal-management conference.

Technical contacts: Alessandro Bertarelli and Stefano Sgobba (Engineering Department)

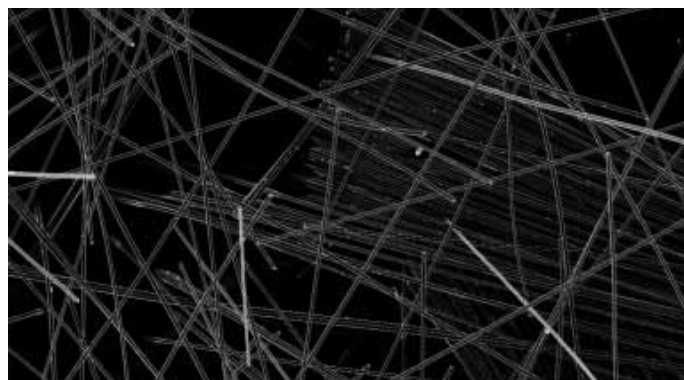

The carbon nanofibre structure in the Mo-Gr thermal management material

Impacts of completed projects

GEM-type detectors for environmental and safety applications

Resistive thick-GEM technologies have a good potential in the environmental and safety field, given their intrinsic robustness, simplicity of assembly and good performance in harsh environments. Two developments were funded by KT in 2012. The flame and smoke detection with a sealed device achieves higher sensitivity than existing commercial devices by using UV-sensitive photo-converters (CsI, Ethyl-ferrocene). Many players in this industrial field prefer to stay with their own technology line, but interest has recently been expressed by a service provider in metering management. Radon (Rn) detection using a device open to air that can be operated stably in ambient air – thus exploiting the detection of α particles from Rn decay – could be used to implement a monitoring network for systematic large-scale studies of Rn increase in the atmosphere as an earthquake precursor. The demonstration detectors are being promoted to relevant industries, while an effort by entrepreneurial students is being co-ordinated to create a start-up on home-use Rn sniffers.

Technical contacts: Antonello di Mauro (Physics Department) and Vladimir Peskov (Goethe University Frankfurt am Main)

Photonic crystals

Photonic crystals provide a novel technology to boost performances of medical imaging positron emission tomographs. The amount of light and its time distribution are key factors determining the performance of scintillators, when used as radiation detectors. This is particularly true when these detectors are used for low-energy radiation, as is the case for time-of-flight PET scanners, for which the demand is increasing. However, most inorganic scintillators are made of heavy materials and suffer from a high index of refraction. This limits light-extraction efficiency, increasing the path length of the photons in the material with the consequence of higher absorption and tails in the time distribution of the extracted light.

Our CERN group, with the support from the KT Fund, has demonstrated the potential of photonic crystals (a thin nanostructured dielectric layer deposited on the surface of a scintillator) to increase the light-extraction efficiency of the scintillation light produced in heavy and high refraction-index scintillating materials. Applied to PET medical-imaging devices, this technology is expected to bring a significant improvement in the energy and time resolution of the detector, with an immediate impact on the signal-to-noise ratio of the reconstructed image. This will improve the image quality with the potential of reducing the doses injected to the patient and increasing the throughput of the PET cameras.

In order to demonstrate the benefit of photonic crystals for PET imaging, the TURBOPET project has been submitted, successfully evaluated in 2014 and funded by the EC in the framework of the EUROSTARS programme. In this project, the company SILSEF (France) is developing in collaboration with CERN an industrial process for the production of photonic crystals, and the company ONCOVISION (Spain) is commercializing the MAMMI breast-imaging PET scanner developed within an FP6 project. MAMMI consists of two rings of detector modules, each ring comprising 12 modules. Each module in turn consists of a scintillator coupled to a position-sensitive photomultiplier tube. In order to be able to compare the improvement in performance parameters owing to the introduction of nanostructures, one ring will be modified so that all the crystals from the 12 modules of that ring are treated with nanostructures to increase light output. The other ring will remain untouched. Hence, the performance properties of both rings (the improved and the untreated) will be compared first on phantoms and then on patients diagnosed with breast cancer.

Technical contact: Paul Lecoq (Physics Department)

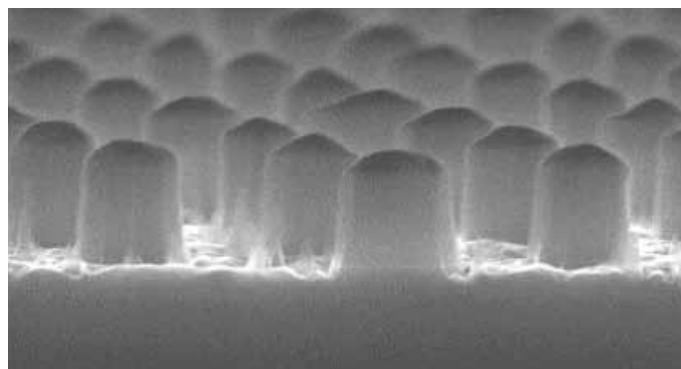

Si₃N₄ layer nanostructured to produce a photonic crystal

microScint

One of the first KT Fund projects, microScint has studied and developed microfluidic scintillation detectors in the Detector Technologies Group of CERN's Physics Department in collaboration with academic partners in Switzerland and Italy. Proof of principle of these novel detectors has been performed with single-layer microfluidic channels filled with a liquid scintillator and read out by external photodetectors, permitting the reconstruction of a particle's coordinate in a plane. Recently, double-layer microfluidic devices have been fabricated by patterning orthogonal microchannels on both sides of thin substrates – silicon and SU-8 photosensitive epoxy, for example. These devices were used to demonstrate the reconstruction of the two coordinates of a particle in a plane, following the approach presented in the patent WO 2013-167151 A1 published in 2013. Potential applications include single-particle tracking and beam monitoring in high-energy physics and medical applications benefitting from the high spatial resolutions obtained by state-of-the-art microfabrication techniques and the increased radiation resistance achieved by circulating the liquid scintillator in the microfluidic channels.

Technical contacts: Alessandro Mapelli and Pietro Maoddi (Physics Department)

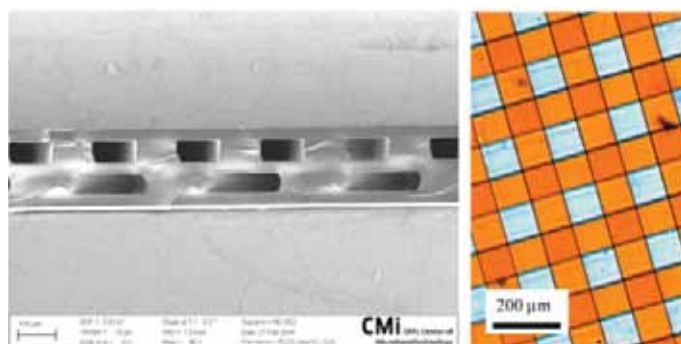

Left: Cross-section of XY microfluidic channels embedded in a thin layer of SU-8 photosensitive epoxy

Right: Top view of XY SU-8 microchannels filled with liquid

Innovation for business

Creativity and innovation flourish when people come together and share ideas, which is why the KT Group actively promotes, encourages and supports cross-sectoral activities. The interaction of research centres and universities, commercial organizations large and small, students, scientists and entrepreneurs transforms the knowledge of high-energy physics into tangible opportunities for business. In particular, 2014 saw the expansion of CERN's Business Incubation Centres of CERN Technologies in the Member States. In addition, the KT Group and ESA co-hosted a pavillion at the 2014 Hannover Messe industrial trade fair.

Business Incubation Centres of CERN Technologies

Austria



Inauguration of the BIC in Austria. Left to right: Michael Moll (CEO Accent), Klaus Schneeberger (MedAustron, Chairman of the Board), Petra Bohuslav (Government of Lower Austria), Sigurd Lettow (CERN Director for Administration and General Infrastructure), Gudrun Hager (Austrian Commercial Counsellor in Switzerland), Reinhard Klank (Austrian Federal Ministry of Science, Research and Economy).

The Business Incubation Centre (BIC) of CERN Technologies in Austria was officially inaugurated on 18 December 2014. The ceremony was organized in the premises of MedAustron, an important example of knowledge transfer from CERN (see p. 19), located in Wiener Neustadt. The partner of CERN in this endeavour is the incubator Accent Gruenderservice GmbH, which is one of seven existing Austrian business incubation centers, and part of the Academia plus Business (AplusB) programme.

Advantage Austria (AUSSENWIRTSCHAFT AUSTRIA) is the official liaison office between CERN and Austrian industry, and had an instrumental role in making the setting up of the incubator possible. The Austria BIC of CERN Technologies will act as an entry point for all Austrian companies and the AplusB centre network, and Accent will be responsible for the administration and implementation of the BIC. The Austria BIC will help in transferring technologies in CERN's fields of expertise to Austria and hopefully will contribute to increasing Austria's capabilities in some key technology areas.

Greece

The signature of the BIC agreement on 1 December 2014 with the Technopolis Thessalonikis Incubator SA, in Greece, is a very good example of return that cannot be readily summarized by a digit or percentage. After the UK, the Netherlands and Norway, Thessaloniki – the second largest city and a historical crossroads of business and commerce in Greece – seized the opportunity offered by CERN's Knowledge Transfer Group.

What are the necessary constituents for this BIC? A key component is a solid partner to drive the effort, spread the word to the right audience and provide inspiration – backed by concrete deeds – to help potential entrepreneurs grab the opportunity that CERN provides. The universities and research centres of Greece, as well as the biggest knowledge hubs of Thessaloniki – the Aristotle University of Thessaloniki (AUTH), the University of Macedonia, and the International Hellenic University – is certainly another. Physicists from AUTH have been actively participating in CERN experiments for a long time, but students from the Innovation and Entrepreneurship Unit can provide valuable help and expertise in management and business services to the small companies in the incubator that do not have the resources to seek new markets and applications for what they offer. The contribution of local and regional authorities is also valuable, as it facilitates the access of fledgling companies to funding, infrastructure and markets, and supports their activities.

According to the president of Technopolis Thessalonikis, Anastasios Tzikas, larger companies are seeking opportunities to invest in innovation and technologies outside their established activities, despite Greece's GDP having been reduced by 30% during the past 6 years. In so doing, they are contributing to a change of business climate that is already visible in Greece. Dissemination efforts, like the BICs undertaken by the KT Group in recent years, seek to address such opportunities.

The Netherlands

Starting in 2013, the possibilities of a CERN BIC in the Netherlands were discussed with CERN's partner institute Nikhef

– the Dutch National Institute for Subatomic Physics – together with funding agencies and venture capitalists. In June 2014, the agreement was officially signed with Nikhef to open a new BIC at the Amsterdam Science Park. Following its counterpart at the Science and Technology Facilities Council in the UK, this BIC will support the development and exploitation of innovative ideas in technical fields broadly related to CERN's activities in high-energy physics such as detectors, cooling technology and high-performance computing. CERN will contribute with the transfer of technology and know-how through technical visits to CERN, support at the BIC and preferential-rate licensing of CERN intellectual property. Nikhef will provide office-space, expertise, business and fundraising support. Preliminary discussions are already underway about the first applicants, and efforts to secure standardized financial support are ongoing.

School of Entrepreneurship. It will also open new possibilities for entrepreneurs in Norway pursuing innovation challenges related to high-energy physics.



Pro-Rector Johan E Hustad from NTNU, left, and CERN's Director for Research and Computing, Sergio Bertolucci, after signing the Norway BIC agreement



The CERN and Nikhef directors Rolf Heuer, left, and Frank Linde sign the Netherlands BIC agreement. (Hanne Nijhuis)

Norway

In October 2014, CERN and the Norwegian University of Science and Technology (NTNU) announced the launch of a new BIC at NTNU's campus in Trondheim. The centre, which is the third CERN BIC, will provide exciting opportunities for starting new companies and further developing fledgling enterprises in Norway that could benefit from CERN's knowledge and technology. As for the other BICs, the incubation centre will offer office space, expertise, business support and access to grant funding. CERN offers up to 40 hours of technical support together with access to CERN and its technologies at preferential rates. The agreement was signed when a delegation from NTNU visited CERN in autumn. The visit coincided with a recurring event, where students from the NTNU School of Entrepreneurship come to CERN for the annual 'CERN-NTNU technology screening week'. This is an educational programme coordinated by the KT Group. Over the course of a week, students assess the market potential of selected CERN technologies. In particular, the students evaluate the potential of starting a new company based on a CERN technology. The scheme has had some recent successes, yielding two start-up companies in the past two years, established by NTNU students. The establishment of the Norwegian BIC will strengthen the existing links between NTNU and CERN for entrepreneurship and commercialization of technologies, by expanding on the collaboration with the NTNU

UK

The first BIC of CERN Technologies was established in the UK two years ago, together with the Science and Technologies Facilities Council (STFC) in Daresbury. It currently hosts two companies that have benefited from CERN's technology and expertise in areas ranging from vacuum technologies to additive manufacturing. It was this original STFC-CERN BIC that inspired other Member States to establish their own national business incubation centres and turn CERN's innovative ideas into business opportunities. The UK BIC has showcased the potential to translate CERN technologies and know-how into successful, profit-making enterprises that will make a positive impact on society and the economy. In addition to the direct technological help, start-ups consider the use of CERN's technology a valuable marketing asset that they can exploit through the CERN technology label that the Organization puts at their disposal. BICs exemplify how technologies developed to answer fundamental questions of modern physics can have an impact outside the high-energy physics community and result in innovative new products and services that can change our daily lives. The principle of BICs is to provide CERN technology, on preferential terms and know-how, in the form of free consultancy, to small or start-up companies who either wish to develop new products and services or need the expertise to improve and expand their existing offer.

Innovation events and initiatives

Hannover Messe

On 7-11 April 2014 CERN took part in the Hannover Messe, the world's leading trade fair for industrial technology. Some 175 000 professionals from 90 countries went to Hannover this year and nearly 50 000 of them visited the R&D Hall, where CERN

shared an exhibition stand together with the European Space Agency (ESA) and other 14 co-exhibitors (spin-off companies from CERN and ESA). In addition to the products from its spin-off companies, CERN showcased technologies in eight different areas, including for example, a demonstrator of the outstanding thermal conductivity properties of the advanced materials developed in the framework of the Eucard-2 project (see p. 49). CERN's IP section of the KT Group drove the initiative with three main objectives:

- supporting the efforts of CERN's spin-off companies in disseminating the technologies originated within the Organization
- implementing the co-operation agreement signed by CERN and ESA in March 2014 with an initiative reflecting the two organizations' many synergies
- showcasing CERN's innovation in several domains, with special emphasis on potential aerospace applications

Overall, the co-exhibitors were very happy with their participation, with new potential clients and co-operation partners found and existing clients met. Apart from the number of contacts made, the spin-offs' delegates reported that having the chance to promote their products as part of the CERN-ESA exhibition gave them excellent visibility and credibility. Considerable media coverage was also given to the initiative, with a media campaign organized in conjunction with the event. Dutch astronaut André Kuipers visited the pavilion and attracted journalists and visitors. A four-minute film was commissioned for documentary purposes and is available online: <http://cds.cern.ch/record/1709754>.



The CERN-ESA exhibition stand at the Hannover Messe

Workshop on Challenges on Additive Manufacturing for High-Energy Physics

Additive manufacturing, often referred to as 3D printing, is emerging as a promising manufacturing technology. Several groups at CERN and in the LHC collaborations are exploring this technology with regard to the possibilities it offers today and in the future for instrumentation development in the area of high-energy physics. The CERN KT Group organized, in collaboration with several technical groups from CERN and the LHC experiments, a one-day workshop on 5 November 2014

under the title “Challenges on Additive Manufacturing for High-Energy Physics”. The purpose was to explore future challenges by gathering a selected community of experts from CERN, the LHC experiments, academia and industry. The workshop was attended by 120 participants, with representation from 15 companies, most of them SMEs.

Full information is available at <https://indico.cern.ch/event/333735/>

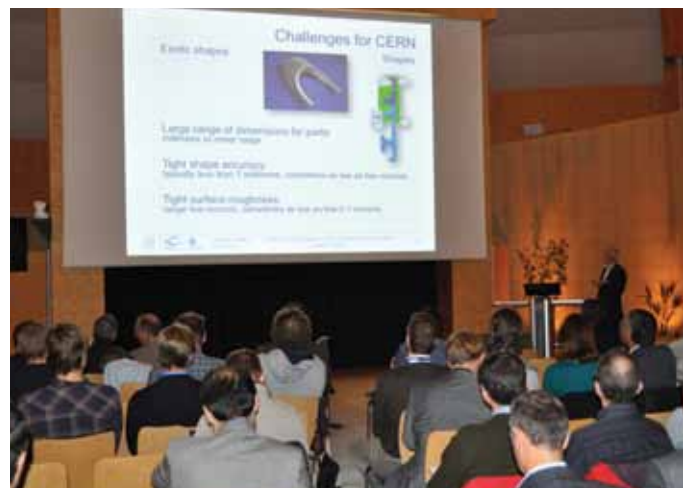

The Workshop on Challenges on Additive Manufacturing for High-Energy Physics, held at CERN in November 2014

CRISTAL – Open Source event

On 15 October 2014 a new version of CRISTAL, 3.0, was launched under the open source LGPL3 licence and is now freely available for all to use and modify. After many years of exploitation under a tailored commercial licence, the move to open source will facilitate collaboration and lower the barrier of entry for new users. The launch event, coordinated by Becky Gooby of the University of the West of England (UWE) and held at CERN, was well-attended by people from industry and the research community. The day consisted of presentations from CRISTAL co-inventors, Richard McClatchey (UWE), Jean-Marie Le Goff (CERN) and Andrew Branson (UWE), as well as an overview from the CEO of M1i, Patrick Emin, on how they as a company use CRISTAL with Agilium software. Afternoon sessions included introductions to Agilium-NG with Olivier Gattaz (M1i) and Patrick Emin, and CIMAG-RA with Florent Martin (Alpha-3i) and Pierre Bornand (CEO Alpha-3i). Jetendr Shamdasani (UWE) presented further applications of CRISTAL within the N4U and neuGRID projects. Attendees were provided with a USB stick containing a copy of CRISTAL to take away to ‘play’ with, alongside information about the CRISTAL-iSE IAPP project, which funded the work.

Idea Square

IdeaSquare is the name of a project designed to bring together ideas and nurture innovation at CERN. This pilot project brings physicists, engineers, industrial partners, early-stage researchers and cross-disciplinary teams of students to work together on detector-upgrade R&D technologies which also have a connection with society. The purpose is to co-develop new technologies for research and, at the same time, create a fruitful environment for socially and globally relevant new product ideas and innovation.

The IdeaSquare building, once an old storage space, has been completely refurbished. It creatively uses repurposed shipping containers and a London route-master bus as office space and a meeting room. Projects can find office space and ready-to-use technical infrastructure for rapid prototyping, in addition to taking advantage of the great networking and idea-sharing opportunities.

For more information see <http://knowledgetransfer.web.cern.ch/ideasquare>



The IdeaSquare building at CERN

Knowledge exchanges

Knowledge exchange and collaboration is the bedrock of CERN, without which the Organization's many experimental achievements would not have been possible. Such exchange is facilitated in part by dedicated networks, a selection of which are highlighted below. The Open Knowledge movement remains a beneficiary of CERN's efforts, particularly with regard to Open Data, Open Access and Open Hardware – also discussed here. Participation in the knowledge-transfer and dissemination aspects of EU-funded projects has been increasingly important for CERN's KT Group in 2014, demonstrating the growing recognition of the role that knowledge-transfer offices play in bringing about the wider impacts of scientific research. In addition to the usual channel of research, knowledge-transfer opportunities also arise through CERN's purchasing and procurement activities – with selected examples presented here.

Networks

ENLIGHT – European Network for Light Ion Hadron Therapy

ENLIGHT was created in 2002 as a networking platform to bring together scientists and experts from different disciplines working on ion therapy. Since its inaugural meeting at CERN, the ENLIGHT community has met again at the Laboratory in 2007 and, most recently, for the 12th annual meeting on 10-12 July 2014. With 145 participants from around the world working in different fields, this meeting highlighted the network's growing membership and showed that multi-disciplinarity is an indispensable component of today's healthcare. Since 2006, ENLIGHT has been coordinated by Manjit Dosanjh, head of the Life Sciences Section. Four EC-funded projects (PARTNER, ENVISION, ULICE and ENTERVISION) have successfully been completed under the ENLIGHT umbrella.

The meeting was opened by CERN's Director-General, Rolf Heuer, who congratulated the network on its achievements and encouraged the collaborative spirit to prevail. Leading experts including Hirohiko Tsujii (NIRS), Eleanor Blakely (LBNL) and Stephanie Combs (Technical University of Munich) discussed the current status of particle therapy in Japan, the Americas and Europe. Damien Bertrand (IBA) and Wolfgang Enghardt (Dresden) discussed the state of the art in industry and medical imaging, along with a vision for the near future. Steve Myers, head of the CERN Medical Applications office, presented CERN's initiatives and explored how to design a future, ideal treatment centre, using accelerator, detector and computing technology from CERN. This set the stage for the afternoon's discussion on future direction.

The discussion on future objectives revolved around four main areas: imaging and diagnostics, treatment planning, clinical trials and training. Accuracy in diagnosis is the key to an effective treatment. Today, diagnostic accuracy is observed to be well behind progress in irradiation techniques. Some of the areas where work is on-going to bridge this gap include functional aspects of multi-modality imaging, addressing the challenges of motion during imaging and adding mathematical models to imaging tools. Accuracy of treatment can be improved by automatic real-time feedback for dose control. Going hand-in-hand with these new techniques is software development for diagnostics and therapeutics.



ENLIGHT poster prizewinners, Thiago Lima (left), Joakim da Silva (behind) and Ander Biguri (right), together with Steve Myers and Manjit Dosanjh

Focus on young researchers

The CERN knowledge-transfer prize was awarded to three young researchers, who were also invited to make brief oral presentations of their work at ENLIGHT's annual meeting. The three winning posters were those of Thiago V M Lima on biological dosimetric phantoms; Joakim da Silva on near real-time dose calculation for hadron therapy on GPU; and Ander Biguri on dual modality electrical-impedance tomography (EIT)-cone-beam computed tomography (CBCT) for lung radiation therapy.

60 years of particle therapy

The ENLIGHT meeting at CERN was the perfect occasion to celebrate two 60th anniversaries – those of the Organization’s foundation in 1954 and the treatment of the first patient with protons in Berkeley (USA). To mark the occasion, Eleanor Blakely, a senior biophysicist at the Lawrence Berkeley National Laboratory, gave the first in a series of public seminars on ‘Accelerating innovation in medicine’. She shared her reflections and perspectives on the 60-year journey of particle therapy starting from the invention of the cyclotron by Ernest Lawrence and Robert Wilson’s proposal to use proton beams therapeutically. Between 1954 and 1957, 30 patients were treated at Berkeley using protons. The first clinical trials were set up in 1975, with 2054 patients being treated with helium ions and 433 with neon ions between 1975 and 1992. She concluded by emphasizing the role of the ENLIGHT network in promoting international research and development, networking and training for students and staff from treatment centres across Europe – both current and those in the making. For Eleanor Blakely’s talk see <https://cds.cern.ch/record/1742288>.

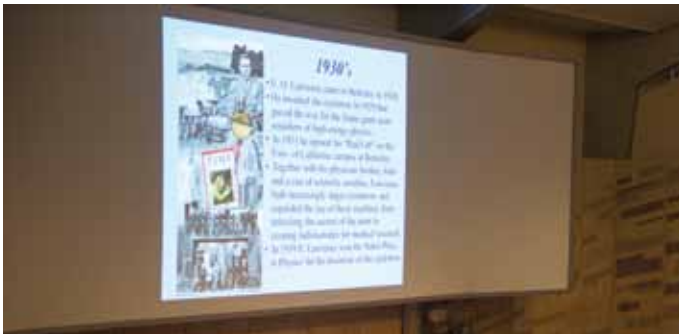

Several aspects need to be considered before devising an effective treatment plan. The more information in a treatment plan, the more personalized it is to the patient. Information on the biological aspects of the tumour, functional imaging and the impact of compounds need to be integrated into the treatment planning system.

Comparative studies are needed on patient preparation and irradiation techniques in order to be able to make ion therapy a more accessible mainstream treatment option. Clinical trials with long-term follow-up help evaluate late-effects of radiation. Since the radiobiological effectiveness (RBE) is the biggest unknown, randomized trials are needed where the RBE assumptions are tested.

Together with technological progress, appropriate training of researchers in the latest technology and machinery is an essential part of the efficient use of a treatment centre. Training should be based on research topics and should include in-depth specific workshops and inter-disciplinary courses. This is of particular importance as the young researchers trained today become the experts of tomorrow. The three-day ENLIGHT meeting not only served as a platform to discuss the future of the ion-therapy community but also provided the opportunity for young researchers to present their work in the form of scientific posters.

HEPTech

The HEPTech Network continues to evolve and grow, having in 2014 welcomed members from Hungary, Serbia and the UK. In June 2014, the network ran the first HEPTech Symposium bringing together early-stage researchers (ESRs) from Germany, Greece, Italy, Romania, and Switzerland in Cardiff, Wales, UK. For one whole week HEPTech welcomed these ESRs to showcase research that has the potential of impacting society, providing an opportunity for networking with commercially experienced professionals and technology-transfer (TT) experts, and developing their entrepreneurial potential. The event received very positive feedback. An evaluation panel composed of experts and a representative of the Welsh Government reviewed the work of the participants. The winner (a PhD student from EPFL, Switzerland) was funded for a trip around the UK visiting companies, investors and funders to see how to secure the next stage of his project.

During the year, events were held in Austria, Bulgaria, the Czech Republic, Germany, Sweden, Switzerland and the UK, exploring detector technology for the future experiments and their upgrades, on subjects that covered topics from marketing of science and technology to high energy lasers and in-kind contributions. Collaborative efforts with European projects, such as the Extreme Light Infrastructure (ELI) in the development of a rationale for a transnational TT office, and also the Joint Research Centre and TTO Circle, resulted in the membership of all three pillars of the ELI project becoming members of HEPTech. The role of HEPTech as a key project in contributing to scientific support for the Danube Strategy was acknowledged by representatives of governments in the Danube countries at the Annual Forum of the EU Strategy for the Danube Region.

EIROforum TWG-IMKTT

The EIROforum Thematic Working Group on Innovation Management on Knowledge/Technology Transfer (TWG IMKTT) is an important framework to identify and exploit bilateral and multilateral synergies between CERN and the largest European international research organizations (EIROs). Enrico Chesta, representing the CERN KT Group, was appointed chairman of the EIROforum TWG-IMKTT in January 2013 and his appointment was extended during the Eiroforum 2014 Autumn DG Assembly for a second 2-year mandate. Several initiatives have been launched in the TWG-IMKTT, including the organization at CERN of the first Eiroforum Science–Business Workshop on Advanced Materials and Surfaces (WAMAS) in November 2013 and the joint CERN–ESA participation in the Hannover Messe in 2014 (see p. 40). Other useful activities have included comparative surveys on Incentive Policies (2013) and on Patent Strategies (2014). In November 2014 a workshop on ‘Tools, best practices and methodologies for Technology Transfer’ was organized at ESO Headquarters with the support and involvement of the Astronet EU project.

TTO Circle

The European Technology Transfer Offices (TTO) Circle was created by the EC’s Joint Research Centre (JRC) to bring together the major European national and international public research organizations to share experience and play a role in collectively driving changes in technology-transfer practices. In January 2014, the Weizmann Institute hosted the sixth TTO Circle plenary meeting in Tel Aviv. The concept of ‘Startup Network’ was further discussed and finally dropped due to a lack of interest of the TTO Circle members. The progress on the CollSpotting/EMM tool developed in collaboration between CERN and JRC was presented. At the end of the meeting, the TTO Circle members agreed to increase the activities aimed at sharing and exchanging good practices.

The first ‘Good Practice Workshop’ took place on 17 June in Brussels and was devoted to the operational and strategic management of TT Office patent portfolio. The workshop was very much appreciated by the participants and it was agreed that similar events should be organized to cover other topics relevant to TT Offices. The seventh plenary meeting took place in Leuven on 16–17 October. The meeting was hosted and organized by the Interuniversity Microelectronics Centre (IMEC) in collaboration with the League of European Research Universities (LERU). The new format of the meeting gives more importance to the sharing of knowledge in the domain of technology transfer and innovation. The EC called for contributions to a high-level workshop aimed at investigating the importance of technology transfer for the adoption of advanced manufacturing technologies.

Open knowledge

Open Access

Open Access empowers everyone to access and re-use, free of charge, publications describing results of publicly-funded research. CERN is committed to Open Access – “[T]he results of its experimental and theoretical work shall be published or otherwise made generally available”, writes the CERN Convention – and funding agencies worldwide increasingly recognize Open Access as a driver of growth and are adopting steps for its implementation. Pursuant to its mission to foster international collaboration, CERN led the establishment of the Sponsoring Consortium for Open Access Publishing in Particle Physics (SCOAP3). Starting in January 2014, this initiative has transformed to Open Access most of the high-quality peer-reviewed journals in the field of high-energy physics worldwide. Thanks to the support of over 2000 libraries and research institutions in 44 countries, scientists around the world can now publish their articles Open Access in these renowned journals, at no direct cost. Authors retain intellectual property right to their works, and permissive ‘Creative Common’ licences allow immediate re-distribution and re-use of the publications’ contents, free of charge, for any purpose, provided they are duly attributed to the authors.

Publishing companies participating in SCOAP3 no longer sell subscriptions to their customers for journals that are now Open Access. SCOAP3 partners can re-use the funds from these reductions in expenditures and pool funds at CERN. Acting for the benefit of SCOAP3, CERN centrally pays publishers for peer-review and Open Access services at competitive prices, thanks to a global procurement process. CERN also continues to move forward with Open Access to its scientific results. Since 2010, all LHC physics articles have been published Open Access, covering about half of CERN’s high-energy physics results. Thanks to the SCOAP3 initiative and additional arrangements with leading publishers, this fraction is now above 90%. In 2014, CERN announced a policy to implement its vision to achieve full and immediate Open Access for its results – making it, to our knowledge, the first research institute in the world to achieve such openness.

<http://scoap3.org>

White Rabbit

White Rabbit (WR) is an extension to Ethernet technology developed in collaboration with many institutes and companies. It allows users to synchronize remote pieces of equipment to within one billionth of a second. The project is completely based on free software and Open Hardware. On the design side, 2014 has been a year of consolidation. Most of the work has gone into making the WR switch more robust and easier to use by non-experts. The maturity of the designs has attracted a large number of users. WR will be used in the KM3NeT deep-sea neutrino telescope in the Mediterranean, and in the Large High Altitude Air Shower Observatory in China, to mention just two prominent examples. These large projects are procuring WR switches and nodes from various companies in CERN Member States.

The 8th WR workshop took place at CERN in October. This informal meeting serves as a gathering point for WR developers and users, and allows attendees to get up to date on the latest developments in this large distributed collaboration. In this edition, a number of possible applications outside physics were presented. Projects include the use of WR technology as a backup for GPS, to synchronize mobile telephony base-stations or to provide real-time distributed acquisition in smart grid applications. There was also progress on the standardization effort to include WR in a future version of the IEEE 1588 standard. Current IEEE 1588 implementations typically feature synchronization precisions in the order of a few microseconds. With WR, precisions are three orders of magnitude better. The CERN team is currently investigating the best way of integrating WR-like functionality into the standard, with the help of the other members in the IEEE 1588 working group.

Cloud computing with OpenStack

CERN's IT computing infrastructure has undergone a major transformation during Long Shutdown 1 to prepare for the upcoming challenges from the Run 2 of the LHC and support a more dynamic and efficient set of cloud-based services. OpenStack, an open source cloud operating system, is a key part of this architecture, which allows users to get compute resources in the time it takes to get a cup of coffee rather than waiting weeks. CERN IT first started using OpenStack in 2012 and has been running in production since July 2013, providing over 1000 users with access to more than 84 000 computing cores across two data centres. More recently, CMS, ATLAS and ALICE have also deployed OpenStack on their high-level trigger farms, providing a further 45 000 cores in compatible clouds for use when the accelerator is not running, as during Long Shutdown 1.

Through various collaborations, such as with KEK (Japan) and BARC (India) and with a CERN openlab Rackspace collaboration, CERN has contributed over 100 improvements to OpenStack and many presentations and workshops at industry and academic conferences on experiences deploying clouds at scale. For this work, CERN's cloud team was presented the inaugural OpenStack Superuser award at the recent OpenStack

conference in Paris, selected from other finalists such as Time Warner, Comcast and Mercado Libre. With over 4500 attendees at the last summit, there are many opportunities to both contribute and benefit from the work of others. New working groups, such as the large deployment working group, are now collaborating together to ensure that OpenStack can continue to grow and provide the framework for the upcoming increase to over 120 000 cores in compute and data analysis capacity needed for Run 2 of the LHC and the needs of other organizations running clouds at scale.



The CERN team receiving the Superuser award at the OpenStack summit in Paris

CERN openlab

CERN openlab, the public-private partnership between CERN and leading IT companies, accelerates the development of cutting-edge solutions for the worldwide LHC community and collaborating research institutes. Testing in demanding and extreme environments pushes technology to its limits, providing the IT industry partners with valuable feedback on their products, while allowing CERN and the collaborating research laboratories to assess the merits of new technologies in their early stages of development for possible future use. In December 2014, CERN openlab completed its fourth three-year phase. During openlab IV, the CERN openlab partners, HP, Huawei, Intel, Oracle and Siemens addressed topics crucial to the CERN scientific programme, such as cloud computing, business analytics, the next generation of computer processors, and security for large-scale network infrastructures. CERN openlab also hosted several projects with Rackspace as a contributor and Yandex as an associate member. Over the three years of this fourth phase, the CERN openlab researchers produced over 60 reports and gave more than 100 presentations. About 30 workshops for the high-energy physics community and 40 lectures for the openlab summer students were also organized.

The five students of ICE-DIP, engaged in 2013 via the Intel-CERN European Doctorate Industrial Programme co-funded by the EC, started in 2014 to complete their secondments and to produce results that are relevant to the LHC experiments and numerous

business sectors. This programme builds on CERN's long-standing relationship with Intel in the CERN openlab project to train the five students who are granted CERN fellowships while enrolled in doctoral programmes at partner universities – Dublin City University and the National University of Ireland Maynooth.

CERN openlab together with a number of European laboratories, such as EMBL-EBI, ESA, ESRF, ILL, and researchers from the Human Brain Project, as well as input from leading IT companies, published a whitepaper on Future IT Challenges in Scientific Research. This whitepaper summarized the challenges and the use-cases identified at a workshop organized in December 2013 and paves the way for defining the engagement of the research organizations and companies for the future. It covers the most crucial needs of IT infrastructures in domains such as data acquisition, computing platforms, data-storage architectures, compute provisioning and management, networks and communication, and data analytics. A number of use-cases in different scientific and technological fields are described for each of the six major areas of investigation.

The scope of openlab is expanding beyond high-energy physics communities to address major computing and data-analysis challenges in as diverse scientific disciplines as healthcare, radioastronomy, neurology or environmental research. In this context, for the first time, a CERN openlab IT Requirement in Healthcare Workshop was organized in autumn 2014 in collaboration with the recently established CERN Medical Applications Office. Healthcare researchers presented their current computing and data challenges to a selected number of leading ICT companies, providing an opportunity to identify areas of joint collaboration.

CERN openlab fourth phase was led by Bob Jones (IT Department). More information: cern.ch/openlab

Below CERN's Director-General, the industrial sponsors and the CERN openlab team members at the third CERN openlab IV annual Board of Sponsors meeting



Open Data

The concept of Open Data goes well beyond the established notion of Open Access to text publications (e.g. SCOAP3), towards the ultimate goal of Open Science. Publishing data openly means that detailed knowledge is shared about the research process and its products, allowing everyone to reuse and reinterpret the data – from citizen scientists to partner projects around the globe. Open Data is thus a core pillar of Open Science but is rarely useful on its own; instead it must be accompanied by other artefacts such as code and documentation.



The start page of the CERN Open Data Portal which makes data available for research and education purposes [<http://opendata.cern.ch/>]

The CERN LHC experiments each have data policies that foresee regular (public) data releases. To make this possible, in November 2014 CERN released a new service, the CERN Open Data Portal, as a joint venture between the IT Department and the Scientific Information Service, developed together with the experiments.

All LHC experiments released data to the public on the portal, predominantly for outreach and training purposes. The CMS collaboration went further and published their 2010 event data in a comprehensive manner. This data release was accompanied by detailed documentation, tutorials and visualization tools. It will be progressively augmented by event data from subsequent years,

and from the other LHC experiments according to timescales in their individual policies. The release of the CERN Open Data Portal set a global example for open knowledge sharing. All materials are released under dedicated Open Science licences. The portal has raised interest from students, citizen scientists, research groups and also private companies who are keen to use the data for their training, art or research purposes – or as a best-practice inspiration for their own big-data projects

Helix Nebula and PICSE

Helix Nebula – the Science Cloud – is a public-private partnership supported by an FP7 EC project that completed in 2014. The work achieved over the past three years has shown that while commercial cloud services are suitable at least for scientific simulation workloads performed by public research organizations, there is a lack of suitable procurement structures for such cloud services to be purchased. A follow-up Horizon2020 project started in October 2014 to create a procurement network of public research organizations named PICSE (Procurement Innovation for Cloud Services in Europe). PICSE will investigate the feasibility and facilitate the concrete preparation of a cross-border PCP (Pre-Commercial Procurement) or PPI (Public Procurement of Innovation) for at least one shared common procurement across public organizations.

More information: www.helix-nebula.eu; hnx.helix-nebula.eu; www.picse.eu

IT data storage projects

One of the hot topics in the IT data storage industry this year has been the emergence of software-defined storage, the goal of which is to build open source alternatives to traditional high-performance network storage appliances. Having significant data-storage requirements, CERN has long been a leader in the field, and in 2014 the CERN IT Data and Storage Services Group initiated a close collaboration with Inktank Storage Inc. (later acquired by Red Hat, Inc.) to evaluate their solution, Ceph. The initial objective was to build a block-storage service for the CERN OpenStack cloud, but it has since expanded to include R&D of Ceph-based solutions to solve future LHC data-storage challenges. The CERN IT Department deployed and now operates a 3 PB Ceph cluster, one of the largest in the world. The team members recognized as industry experts have been invited to give presentations at Ceph workshops in London and Frankfurt. In addition, the CERN developers have contributed significant new features to this open source project, including erasure coding libraries for efficient space utilization and an object striping library for high-performance data-analysis applications. The growth of the Ceph project at CERN has demonstrated that CERN's storage requirements are beginning to overlap with the capabilities of open source projects emerging from industry.

The largest disk-storage system used at CERN – EOS – is used by LHC and non-LHC experiments primarily for physics analysis. EOS is built from commodity hardware with 120 PB of raw disks, a third of them installed in CERN's new computing facility at the Wigner Research Centre for Physics in Budapest,

Hungary. The EOS project started in 2010 to address the growing demand of data storage for CERN LHC use-cases. It is an innovative software storage-solution providing fast and reliable storage, accessible via several secure protocols using a strong authentication scheme, a robust quota system and a minimal cost of operation. All EOS software is publicly accessible as open source and has been released under GPL v3 licence, contributing to its fast growth at CERN and its quick adoption in eight other physics institutions around the world. The CERN development team is actively improving the software to keep it at the topmost performance and reliability and is now implementing cloud support for external synchronization clients.

EU-funded research collaborations

EU projects are increasingly important in CERN's activities and the KT Group's involvement has been growing accordingly, also as a result of the significant emphasis that the EU has recently put on aspects of innovation and dissemination – part of KT's mission at CERN. Indeed, the work packages of EU projects such as AIDA, Hi-Lumi and EUCard contain specific tasks dedicated to knowledge transfer, in areas such as industrial relations and outreach. For each of these projects, the KT Group has collaborated with the EU Office at CERN, providing support to the technical departments and helping them to identify the technologies that are potentially capable of producing a paradigm shift.

Hi-Lumi

The Hi-Lumi LHC Design Study project started in 2011 under FP7 and will finish at the end of October 2015. It is aimed at increasing the luminosity of the LHC machine by a factor 10 in order to expand the discovery potential. Many challenging aspects of the project demand extended collaborations with industry and partners that are not exclusively European, making the project a real global endeavour. The project has already established important industrial contracts for the preparation of the first prototyping magnets, and the KT Group has prepared outreach documentation to explain the technologies involved, their possible application outside of high-energy physics, and the need for upgrading the luminosity of the LHC machine. The group also participated in the annual meeting of the collaboration, and is preparing for an information day to be held in summer 2015, aimed at informing companies about the scope, timeline and legal framework of the large procurements that are expected for the implementation of the Hi-Lumi LHC projects.

Future Circular Collider (FCC)

The KT Group has been involved in work on the proposal for the Future Circular Collider (FCC), taking care especially of the relations with industry in preparation for the first annual meeting in Washington in March 2015. Companies active in the domain of superconductivity and in the technology of additive manufacturing have been contacted and invited to present their capabilities and to participate in topical meetings with collaboration members. The aim is to define the sectors of

R&D that will need special development in order to meet the challenging requirements of the new machine, currently under conceptual design.

AIDA and AIDA-2020

The aim of the AIDA project was to address infrastructures required for detector-development for future particle-physics experiments. Starting in February 2011, under the EU's FP7 programme, it concluded at the end of 2014, with important results bringing the detector R&D to a pre-industrialization phase. The KT Group monitored the developments of the technologies involved, and in so doing helped to identify the right path to industrialization via prototyping.

At the same time, the group has been involved in the natural progression of the AIDA programme, taking care of a specific work package in AIDA-2020. This is the proposal prepared under the H2020 framework, where the EU requires more active and extended industrial participation. Industry plays a crucial role in the construction of big particle-physics experiments; the extremely challenging requirements and the very large number of components make this area especially fertile for innovation. Indeed, a specific work package on innovation – including social innovation of research infrastructures by reinforcing the partnership with industry – has been included in the work programme of AIDA-2020, following suggestions from the EU. Presentations were made at the February and April 2014 AIDA meetings for the finalization of the proposal and definition of its scope.

EuCARD-2

EuCARD-2 is an Integrating Activity Project for coordinated R&D on particle accelerators, co-funded under FP7. The project has 40 partners from 15 European countries, including 10 accelerator laboratories, notably CERN, 23 technology institutes/universities, 5 scientific research institutes and 2 industrial partners. One of the work packages (WP) is devoted to knowledge transfer, and is led by the KT Group. The WP team has worked across all activities within the EuCARD-2 consortium highlighting the technologies that are closest to the industry and where there is a significant potential for knowledge transfer of technologies developed within EuCARD-2. Contacts have been made with all EuCARD-2 WP leaders, enabling closer monitoring of any potential developments, attending key workshops and collaborating where appropriate with some of the WP leaders on networking events with industry for knowledge transfer. The activities within this task can be grouped in two categories:

- Technology scouting: performing interviews with WP leaders to identify key technological areas within EuCARD-2 that may become future objects of dissemination activities and 'EuCARD-2 meets the industry' events.
- Technology promotion: actively marketing the technologies with higher maturity-rate from EuCARD-2 to industry and other research organizations outside the consortium.

Key technological areas that are potentially of interest to industry have been identified within EuCARD-2, in addition to an exploitation/industry engagement mechanism for knowledge

transfer. A questionnaire was drafted to address these objectives. Active technology scouting within the EuCARD-2 consortium was then carried out via interviews with representatives from the various WPs. The results of these interviews provided focus for the 'EuCARD-2 meets the industry' events that will bring the researchers together with industry with a view to forming new partnerships and exploring the potential for knowledge transfer. The progress, notably, of thermal-management materials in WP11 was presented at WAMAS in 2013 and during the Hannover Messe in 2014.

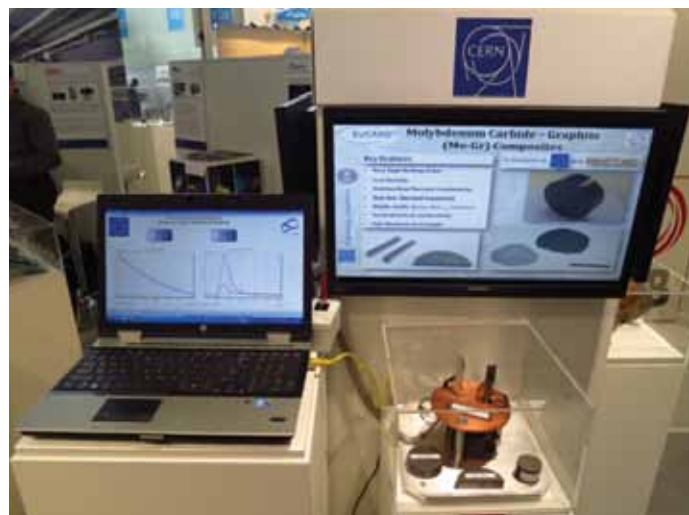

Demonstrator of the outstanding thermal properties of the EuCARD-2 advanced MoGr materials

International organizations

Thanks to a structured network of relations with other international organizations (IOs), CERN on one hand promotes the importance of science, scientific education, technology and innovation as a driving element for a sustainable development of society, and, on the other hand, provides other IOs with its experience as a major scientific research institution whose activities also offer models of peaceful cooperation between different cultures.

CERN collaborates with the World Intellectual Property Organization (WIPO) on issues related to intellectual property and technology transfer, innovation (Global Innovation Index), and technological competitiveness. CERN also collaborates with the World Health Organization (WHO) on possible applications of accelerator and detector technologies to medical fields. The direct contact between CERN and WHO shortens the "distance" between particle-physics technologies, the medical world interested in specific applications, and the companies able to develop, industrialize and adapt the technologies to the needs.

In March 2014 CERN signed a Co-operation Agreement with the European Space Agency (see p. 50). The agreement provides a global framework for collaboration between the two organizations, which foresees specific implementing agreements in fields such as computing and data preservation, advanced materials, cryogenics, superconductivity, radiation resistance etc. The first implementing agreements, planned to start in the

first part of 2015, include radiation-resistance of electronics components and equipment.

In 2014 CERN intensified its contacts with the World Trade Organization (WTO). CERN's Director for Accelerators and Technology, Frédéric Bordry, was a panelist in a workshop on trade and transfer of technology organized by WTO in June. His panel discussed 'Trade and technology transfer for sustainable development and new trends in transfer of technology cooperation'.

In September the Organization for Economic Co-operation and Development (OECD), issued the report 'The impacts of Large Research Infrastructures on Economic Innovation and on Society – Case studies at CERN'. The report is focused on two case studies: the LHC superconducting magnets and hadron cancer therapy. It shows the importance for an institution like CERN to be able to count on an effective knowledge-transfer strategy when tackling big projects such as the LHC. It also stresses the benefits for society at large, thanks to the spin-offs that go well beyond purely scientific and technological interests CERN's needs to achieve its programmes.

In October, in the context of the celebrations for the 60th anniversary of CERN, the United Nations and CERN organized a major event at the UN Headquarters in New York, titled 'CERN: Sixty years of Science for Peace and Development'. In addition to CERN's Director-General, Rolf Heuer, and the UN Secretary-General, Ban Ki-Moon, the event included high-level speakers such as the presidents of the UN General Assembly and the UN Economic and Social Council, Kofi Annan, Carlo Rubbia, Fabiola Gianotti and others. The role of knowledge transfer for the development of society was repeatedly stressed during the event. In November CERN hosted the 'International Conference on Standardization and Innovation' organized by the International Organization for Standardization (ISO) and actively participated in different panels. The KT Group was the main CERN participator in the event and the quality of the contribution provided by CERN was highly appreciated by ISO.

CERN-ESA Cooperation Agreement

On 28 March 2014 CERN and the European Space Agency (ESA) signed a framework agreement for future co-operation on research and technology in areas of mutual interest. CERN's IP Section has identified in this context some 12 areas of promising potential technological collaboration, including the development and verification of radiation-hard electronics, the sharing of cutting-edge facilities, synergies in the field of big-data handling and storage, innovative materials for applications in extreme environmental conditions, development of miniaturized technologies for micro-cooling and radiation monitoring and shielding technologies. Such collaboration is considered as a strategic axis for future development. During the signature ceremony, CERN's Director-General stated: "CERN and ESA have common roots and share a long history of pioneering research work in their respective fields. This new co-operation agreement will foster synergies between the expertise, know-how and facilities available in the two organizations." In 2014 the joint participation of CERN and ESA in the Hannover Messe trade fair (see p. 40), organized by the KT offices of the two organizations, provided the first opportunity to showcase their close links.

KT through procurement

Nb₃Sn magnets project

The service contracts for the prototyping and industrialization of Nb₃Sn magnets for the HL-LHC project provided valuable support to CERN in 2014. These contracts, with the firms Alstom (France), ASG Superconductors (Italy), Babcock Noell (Germany) and Oxford Instruments (UK), have allowed significant progress in the development and construction of the tooling necessary for the fabrication of superconducting coils for the 11 T dipole project. For example, the implementation of the instrumentation of 2-m long model coils and the fabrication of the very first 5.5-m long practice coil with braided copper cable were successfully completed.

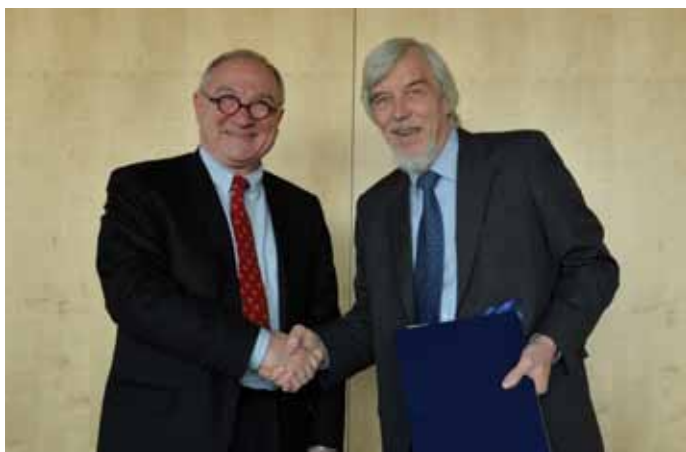

ESA Director-General, Jean Jacques Dordain, and CERN Director-General, Rolf Heuer, after the signing of the Co-operation Agreement between CERN and ESA



Close-up of the Nb₃Sn magnet core

TransElectro: co-operation on a new product

The operation of the LHC relies on superconducting magnets to create the powerful field to guide the particle beams. However, events can cause the magnets to return to their resistive state (quenches). The LHC is therefore equipped with an advanced quench-protection system (QPS), whose role is to detect quenches and to initiate the appropriate response to protect the magnets. A part of the QPS consists of strip heaters that, upon detection of a quench, are energized in order to dissipate the energy produced by the transition from the superconductive to resistive state. In 2009, a series of quenches brought the LHC to a halt and caused more than a year's delay in the research programme. Although a solution was found, several upgrades were needed to improve the QPS during the first long shutdown (LS1). The Circuit Protection Section, led by Knud Dahlerup-Petersen, was in charge this upgrade and once the necessary measures and the technical requirements had been defined, they looked for suppliers capable of delivering the required technologies. One of the tenders concerned 5200 measurement-transformers to control the power supplies for the strip heaters for the 1250 magnets.



Per Christensen (left), sales manager at TransElectro, showing the core of the future transformers to Knud Dahlerup-Petersen (centre), QPS Section Leader at CERN, and Andrzej Siemko, head of the Machine Protection and Electrical Integrity Group

The Danish company TransElectro is specialized in the production of transformers and coils and had been involved in a few CERN contracts as subcontractor, but never as a direct supplier. With the backing of the Industrial Liaison Officer for Denmark at CERN, the sales manager Per Christensen took up the challenge, and the company won the contract for the measurement transformers. Before ordering all of the 5200 transformers, Dahlerup-Petersen required that the first prototypes were tested for their precision and performance. He arranged with Christensen to test TransElectro's prototypes at an independent test-facility in Berlin.

The tests showed that the transformers produced by the Danish company worked satisfactorily but both CERN and TransElectro could see that some improvements could be made

in order to deliver the best result. So, the two partners decided to work together to find a better solution that would ensure a longer lifetime and a higher performance of the measurement transformers. During a period of 3 - 4 months engineers from CERN exchanged ideas, experiences and knowledge with engineers from TransElectro. The engineers from CERN developed new test equipment and software and sent it to Scandinavian Transformer, TransElectro's daughter company and production site in Poland, where several prototypes were tested until they finally reached very stringent precision and performance requirements to the great satisfaction of Dahlerup-Petersen: "TransElectro managed to deliver a good product at the best price, so we are very satisfied with this cooperation".

Knowledge-sharing events

THE Port hackathon at CERN

Organized by THE Port Association, hosted by CERN IdeaSquare (see p. 42), and with partners from other NGOs, a 3-day problem-solving workshop or hackathon devoted to humanitarian, social and public interest topics took place at CERN on 31 October – 2 November 2014. It brought together 6 interdisciplinary teams from 28 different nationalities to tackle a variety of modern humanitarian challenges with high technology. Of the 58 participants, 30% work or have worked at CERN, 12% work in the IT sector and 16% at humanitarian organizations. The remaining third work in communication, innovation, science, engineering, education, design, arts, or are still students. The teams were balanced in expertise, age, culture and gender (33% female participation) to reach optimal diversity and the full potential to look at tasks from multiple perspectives. Surrounded by experts from CERN and field experts from NGOs, the teams produced tangible proof-of-concept prototypes towards improving the day-to-day work-life of humanitarian workers.

THE Port association (a non-profit association under Article 60 of the Swiss civil code) aims at combining creative minds from CERN and non-profit organizations to work on technological solutions beneficial to society. Encouraged by the successful outcome, together with the excellent feedback from the parties involved in this first hackathon, THE Port association looks forward to organizing another event in 2015.

More information: www.theport.ch

Training and education

Training and education is a fundamental component of CERN's mission. In addition to the training available for young scientists and engineers, such as with the Marie Skłodowska-Curie actions, there are also opportunities to gain in-depth knowledge about the Laboratory's research at the extensive programme of CERN schools (see p. 55). In 2014 the KT Group also started its own in-house training course on knowledge transfer, open to all CERN personnel.

KT training for CERN staff

In 2014 the KT Group began offering in-house training courses for CERN staff and students on knowledge-transfer topics. Currently, the group offers two courses: 'Introduction to Knowledge-Transfer Tools' and 'Building up and writing proposals for EU H2020 projects' (see below). Based on feedback from participants, the group plans additional courses in greater depth on specific topics such as intellectual property and entrepreneurship. The courses serve multiple purposes, most importantly providing researchers and engineers with complementary skills. However, they also provide a way of informing the CERN community about the services that the KT Group can offer, and an opportunity to meet with personnel interested in discussing these topics.

Introduction to KT tools

The half-day 'Introduction to Knowledge-Transfer Tools' gives an introduction to intellectual property, contracts for knowledge transfer, and projects involving industry and other external partners. The purpose of the course is to give essential information about how to secure ownership of inventions and to provide information on legal and contractual considerations when transferring knowledge and technology, or when doing collaborative R&D. Two sessions of the half-day course were arranged in 2014, with almost 60 participants in total. Three new sessions are scheduled for 2015.

EU H2020 Proposal-writing training for CERN Staff

In collaboration with the EU Office at CERN and the Human Resources Department, the KT Group organized the course 'Building up and writing proposals for EU H2020 projects'. The course was open to CERN staff and fellows with the aim of helping prospective proposal-writers to build and prepare competitive proposals under the new EU Horizon 2020 programme. The 2014 course was attended by 25 participants. It is intended that it will become a regular activity based on potential future demand.

Training programmes

CERN offers attractive programmes for undergraduate students to spend time at CERN while working on their bachelor/master's thesis or to gain practical training experience.

The technical student programme is for engineering and applied physics students who come for 4-14 months and who are selected twice a year at selection committees held at CERN. In 2014, around 170 students were selected, 50% of whom were informatics students. The administrative student programme is the equivalent programme for students specializing in administrative fields and some 30 students were selected in 2014.

The flagship programme, is the summer student programme for physics and engineering students from both Member States and also non-Member States who have no previous link to CERN. The students join the day-to-day work of research teams during the summer period, and follow the lecture programme in which scientists from around the world share their knowledge on a wide range of topics in theoretical and experimental particle physics and computing. Visits to the accelerators and experimental areas are also part of the programme, as well as discussion sessions and workshops. Students are given the possibility to present their project work at a student session or a poster. This year some 300 students from 77 different countries joined the programme.

The doctoral student programme is for postgraduate students who wish to prepare a doctoral thesis in a technical field. This is done via a collaboration between CERN and the university to which the student is affiliated. The highlight of 2014 was an assembly organized at CERN for the 170 doctoral students in which 20 of them prepared a poster on their work. This enabled them to meet the Director-General, get to know each other and share their knowledge. It was also a great success.

Marie Curie Actions

The year 2014 saw the end of the EC's 7th Framework Programme. CERN was particularly successful in the Marie Curie Actions (MCA) and was in the top five of beneficiaries (in budget terms).

The main focus of the MCA was career development in a research and training context through 11 Initial Training Networks (ITNs) coordinated by CERN (plus 8 more as partner) and 4 COFUND grants that supplement the CERN Fellowship Programme. There were also fellowships for 15 individual researchers. Transfer of knowledge was strengthened by involvement in two exchange

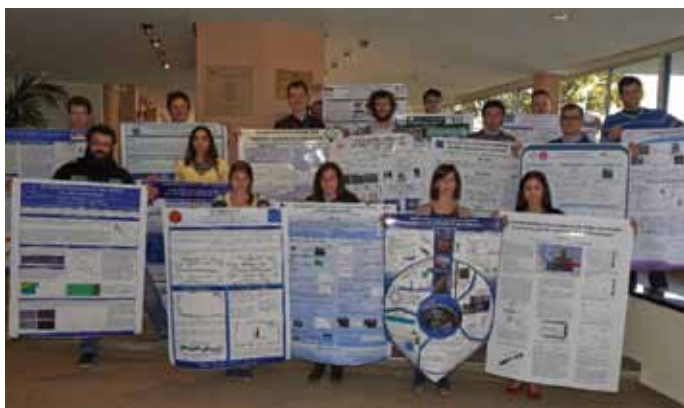

Doctoral student poster Session in April 2014

projects between academia and industry and one scientist exchange project focusing on relations between CERN and South America. Budget-wise, the MCA contributed nearly 56 million euro, with the COFUND grants alone accounting for half of this.

The ITNs brought a total of 206 researchers to CERN for periods of 3 – 36 months in a range of topics in physics, engineering, computing and medical applications. The COFUND grants allowed CERN to give 185 fellows a guaranteed third year of contract (instead of the regular two). The greatest consequence of the MCA funding is that it allowed us to recruit additional fellows that otherwise we would not have been able to support through the regular budget. It also allowed us to pursue new avenues of research, in particular in medical applications.

The new Framework Programme, Horizon 2020, started on 1 January 2014, with the MCA renamed to Marie Skłodowska-Curie Actions and a stronger focus on industrial involvement. CERN has already been successful with one new ITN (where 'I' now stands for innovative) and two new Research and Innovation Staff Exchange (RISE) projects. The first COFUND proposal under Horizon 2020 was submitted in October and new applications for ITNs are being prepared for submission in January 2015.

Marie-Curie Rise INTELUM project

The INTELUM project has been initiated by CERN for funding international, industry-academia exchanges to develop micro-pulling-down crystal-growth and other new types of fibre technology. This new fibre-production technology has the potential to enable fast, low-cost, manufacture of heavy-crystal scintillating fibres for high-energy physics as well as for medical-imaging devices and other applications (homeland security), illustrating once more the societal impact potential of technology developments initiated for fundamental sciences. INTELUM – International and intersectoral mobility to develop advanced scintillating fibres and Cherenkov fibres – is a 4-year project that has been officially approved for funding by the EC in 2014 in the framework of the Marie-Curie Rise programme.

The ambitious project will be undertaken by an international consortium of 16 institutes and companies worldwide, many closely linked to the Crystal Clear Collaboration. The staff to be exchanged will include group leaders, key scientists and key technologists from all participating bodies. Their role will be to initiate and supervise the new collaborative activities and to deliver training courses, lectures and series of advanced seminars for the less experienced staff from the other participant organizations. The bulk of the exchange visits will be undertaken by experienced researchers, who will work on the implementation of well-defined tasks at their host organizations. We also envisage exchanges of some technical staff to assure transfer of knowledge in technical aspects of the experiments and management staff to help organize project meetings and provide overall management support.

Technical contact: Paul Lecoq, Physics Department

The general public and teachers

The CERN Education Group organizes guided tours, exhibitions and teacher schools to bring the research and technology at CERN to the general public and into the classroom. About 103 000 visitors (40% of which are school children) followed 1/2-day guided tours to dedicated visit points in 2014, but with more than 300 000 requests per year, not all potential visitors could visit the laboratory. New visit points were inaugurated, namely in the Data Centre, the CERN Control Centre and SM18. A completely new exhibition around the Synchrocyclotron – CERN's oldest accelerator – featuring a 12-minute long video and light show, was inaugurated in June 2014 and has since enjoyed great public success.

Two permanent exhibitions, 'Universe of Particles' and 'Microcosm', were seen by about 65 000 visitors. As part of the 60th anniversary programme, CERN exhibitions were shown in 16 other locations. The large 'Accelerating Science' exhibition went to Warsaw, Athens, Valencia and Thessaloniki, attracting more than 300 000 visitors. The 'interactive LHC tunnel' – a high-tech audiovisual installation to allow playful exploration of proton collisions in the LHC or to visualize the Higgs field – travelled to eight different locations and was shown together with a large poster exhibition. Other more thematic CERN exhibitions were shown at four other venues.

Training courses for secondary-school teachers, who play a key role in motivating and inspiring their students, continued. The programme consists of lectures on particle physics, cosmology, CERN technologies and applications, as well as workshops and guided tours to facilities and experiments at CERN. The level of the lectures is chosen so that the content is suitable for school teaching. There were 34 one-week programmes, which were held in 19 different national languages and saw a record participation of 1200 school teachers from 22 different countries. In addition, the international three-week High School Teaches programme in July had 54 participants from 32 different countries, including 10 teachers from the Middle East (Bahrain, Iran, Israel, Jordan, the Palestinian Authority and Turkey) whose countries co-operate in the SESAME project.

Career study of former CERN fellows

Each year CERN attracts many young scientists, engineers, technicians and other professionals to take part in a wide range of research, in particular through the Fellowship Programme. After a period at CERN, they often move elsewhere to positions in academia and industry. This is an important knowledge-transfer process, whose socio-economic impacts are difficult to assess. In order to investigate this dimension of knowledge transfer, the KT Group, in collaboration with Silvia Bruzzi (University of Genoa, Italy), conducted a survey on the impact of CERN fellowships on the professional career of the past fellows. Data were collected by an anonymous electronic survey sent to those who finished their fellowship in the period 2007-2012 and at the time of the survey were not associated with CERN in any kind of contract. There were 133 responses, giving a response rate of 46%.

The results show that the almost all of the former fellows had found new jobs after leaving CERN. Only 5% were unemployed since ending their fellowship, which is an exceptionally low number considering that the survey was sent out shortly after the end of the fellowship for those finishing in 2012. This is an important testament to the employability of former CERN fellows. In addition, 73% reported that the fellowship had a positive impact for securing their first position after leaving CERN (important impact: 32%, very important impact: 27%, determinant impact: 15%). There are also good indications that taking a research fellowship at CERN contributes to starting an international career, as more than half of the responders took a position in country different from where they gained their university diploma, and continued to stay abroad.

Fellows find jobs in a wide range of fields. Many continue to stay in universities or other research centres, but 42% of them took positions in industry, working mainly in big companies acting in: high-tech sectors, such as ICT, finance, banking and insurance, or mechanics; the field of R&D; high-tech business functions (IT, security and operations). The survey also demonstrates the multi-dimensionality of the knowledge transferred to fellows, who describe their fellowship as a learning experience, important for their future career and very useful for learning technical knowledge and soft skills (cooperation, working in team, communications skills, independent working and the ability of dealing with responsibilities). This gives an important testament to the positive external effects produced by research and education activities developed at CERN for the widest benefit of the society.

For more information see: S Bruzzi and G Anelli The EuroAtlantic Union Review 115 vol.1 no.2 (2014)

CERN Spring Campus

The CERN Spring Campus took place for the first time in April 2014, in Oviedo (Spain). This new school had around 80 attendees (undergraduates) from 5 universities, mainly from northern Spain. The focus of the school was principally IT, however the topics presented also aimed to prepare and equip the young attendees to enter the job market. These included sessions such as CV writing, job-interview tips (from CERN's HR Department) and information on how to apply for government start-up grants.

For more information see <http://cern.ch/springcampus>

Sector of the employers

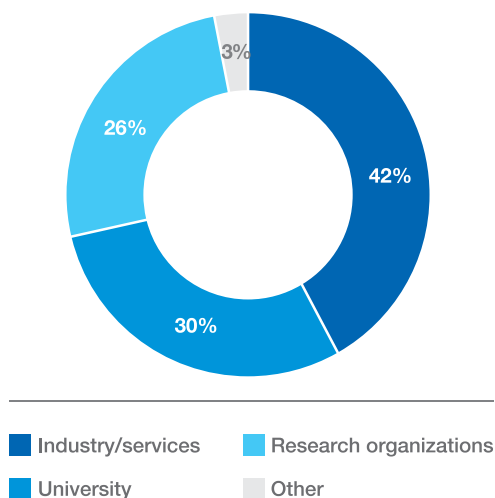

Field of industry/services

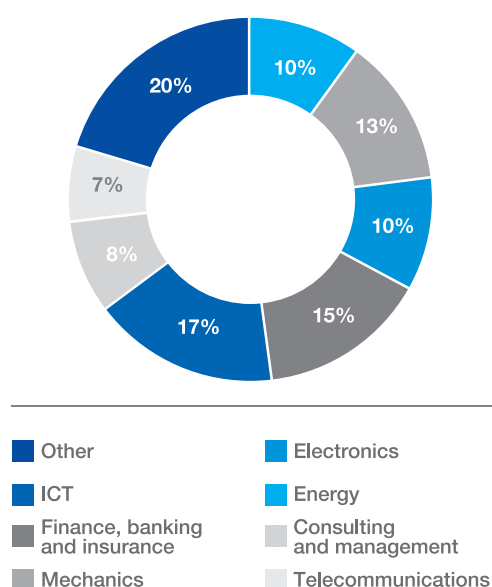

CERN schools

CERN organizes or co-organizes several schools every year, teaching hundreds of students and having a global impact.



▼ AEPSHEP

Asia-Europe-Pacific School of High-Energy Physics

Puri (India), 4-17 November
64 participants, 22 nationalities
Chair of IOC: Nick Ellis

<http://2014.aepshep.org/>

▼ AIS-GRID

Grid and advanced information systems

Dubna (Russia) 20-24 October 2014
115 participants, 15 universities
Chair of OC: Nikolai Rusakovich

<http://ais-grid-2014.jinr.ru/>

▼ CAS

*CERN Accelerator School
Basics of Accelerator Science and
Technology*

CERN, Chavannes de Bogis (Switzerland),
3-7 February
79 staff from CERN
Director: Roger Bailey

<https://indico.cern.ch/event/276062/>

▼ CAS

*CERN Accelerator School
Basics of Accelerator Science and
Technology*

Prague (Czech Republic),
31 August – 12 September
111 participants, 29 nationalities
Director: Roger Bailey

<http://cas.web.cern.ch/cas/CzechRepublic2014/>

▼ CAS

*CERN Accelerator School
Plasma Wake Acceleration*

CERN (Switzerland), 23-29 November
109 participants, 27 nationalities
Directors: Roger Bailey and Bernhard Holzer

<http://cas.web.cern.ch/cas/PlasmaWake2014/>

▼ CAS

*CERN Accelerator School
Power Converters*

Baden (Switzerland), 7-14 May
85 participants, 21 nationalities
Director: Roger Bailey

<http://cas.web.cern.ch/cas/Switzerland-2014/>

▼ CSC

CERN School of Computing

Braga (Portugal), 25 August -5 September
61 participants, 28 nationalities
Director: Alberto Pace

<http://indico.cern.ch/event/298406/>

▼ ESHEP

European School of High-Energy Physics

Garderen (the Netherlands), 18 June-1 July
100 participants, 32 nationalities
Director: Nick Ellis

<http://physicschool.web.cern.ch/PhysicSchool/eshep/eshep2014/>

▼ iCSC

Inverted CERN School of Computing

CERN (Switzerland),
24 February – 25 February
91 participants, 21 nationalities

Director: Alberto Pace
<https://indico.cern.ch/event/281860/>

▼ ISOTDAQ

*International School of Trigger and Data
Acquisition*

Budapest (Hungary), 28 January –
5 February

51 participants, 19 nationalities
Director: Markus Joos

<http://isotdaq.web.cern.ch/isotdaq/isotdaq/2014.html>

▼ Joint USA-CAS

*CERN Accelerator School
Beam Loss and Accelerator Protection*

California (USA), 5-14 November
60 participants, 22 nationalities

Directors: Roger Bailey and Bill Barletta
<http://uspas.fnal.gov/programs/JAS/JAS14.shtml>

▼ JUAS

Joint Universities Accelerator School

Archamps (France), 6 January -14 March
65 participants, 18 nationalities

Director: Louis Rinolfi
<https://espace.cern.ch/juas/>

▼ tCSC

Thematic CERN School of Computing

Split (Croatia), 15 June – 21 June
24 participants, 15 nationalities

Director: Alberto Pace
<http://indico.cern.ch/event/282910/>

CERN
Knowledge Transfer Group
Communication Group

CERN-Brochure-2015-001-Eng

©Copyright 2015, CERN

Articles

All articles are by CERN except:

- p. 17 CNAO
- p. 18 MedAustron
- p. 51 TransElectro

Photos

All photos are by CERN except:

- p. 6 University Hospital Heidelberg
- p. 9 Eugene Theodore
- p. 12 ENVISION / Nymus 3D
- p. 19 CNAO (left), MedAustron (right)
- p. 20 University of Manchester
- p. 27 Aalborg University
- p. 38 SILSEF (left)
- p. 39 NLK J Burchhart
- p. 40 Hanne Nijhuis (left)
- p. 41 Hannover Messe (left)
- p. 46 OpenStack Foundation
- p. 47 Dave Sims
- p. 51 TransElectro



cern.ch/knowledgetransfer